

endrich news

www.endrich.com



A year of joy

Dear reader

This year is really a year of joy. First, our CEO, Dr. Christiane Endrich, has been appointed by the readers of Markt & Technik, a famous

German electronic magazine, as "Manager of the Year 2016", and now we received six awards from the electronic magazine Elektronik and were voted "Distributor of the Year 2016".

We want to thank you most sincerely for your vote!

In the product field of **displays**, regarding

- technical competence & support
- availability in volume
- delivery service of samples

Additionally, we could get the award for second place in the category **passive components** with

- delivery service volume

and received two further awards in the field of **displays** with the criteria:

- general impression
- delivery service volume

We are very proud that we could get such important awards by our readers – that means you – and that you had positively judged our activities as one of the major distributors in Germany!

We will also in future be fully dedicated to offer new products and solutions for our customers and give you our very best support.

Therefore, we are glad to invite you to visit our booth at electronica in Munich from November 8th – 11th, 2016, **in hall 5, booth 124**. We hope that we can welcome you to our booth. We will show our newest, very interesting, novelties. Especially on the field of IoT and help you in the competition of new innovations in the market.

W. Endrich



Picture: Horacio Canals / Elektronik



TUNING FORK SERIES CM315 FROM CITIZEN FINEDEVICE



Due to the ongoing miniaturization of electronic devices, manufacturers of passive and active components strive to reduce their component design. This applies also to clock crystals which are widely used in application as home automation, Metering or mobile phone which requiring a precise timing frequency. The time reference is provided often by tuning fork quartzes. Based on the 32.768 kHz, the one-second interval is generated by dividing the frequency.

The effect of the miniaturization of conventional quartz is often underestimated. Reducing the size means in most cases also reduction of the inner quartz blank. This usually causes an increase of the ESR value (Equivalent Series Resistance). But precisely this resistance should be as low as possible in order to ensure a high "Q"-value and reliable start of oscillation. In addition take into account that a higher ESR will increase the power consumption. Because in order to maintain the quartz oscillating it is necessary to permanently supply the crystal with energy and the higher ESR cause bigger losses. Since the frequency of the processors increases as well over last time, keep in mind that effects of EMI became more important in quartz design

Fortunately Citizen FineDevice offer different solution in a very small 3.2 x 1.5mm package for the challenges of an oscillator design. The standard Type CM315D offer a ESR of 70 kOhm. With the Type CM315DL the Citizen engineers succeeded despite concomitant miniaturization to guarantee an ESR value of 50 ohms. An improvement of approximately 30% compared to the usual ESR of 70 kOhm for a 3.2 x 1.5 mm tuning fork design. This tuning fork is therefore perfectly suited in application using battery power supply as „low power micro computer“ applications.

Further more Citizen released a Type, the CM315E series. To interconnection terminals are realised on one side of the crystal package. This provides new variations in the design of the circuit board and even more important allow especially to Reduce trace lengths to the processor input s much as possible This improve the EMI performance. A Crystal units with excellent Freq stability and hard to receive the effect of noise. Recommended for noise sensitive Applications. This CM315E version it will be launched soon as well in the low ESR version (CM315EL).

The crystals are manufactured with most common load capacitance of 12.5 pF. 9.0 pF, 7.0 pF 6.0 pF are also feasible.

CM315D – 3.2 x 1.5 mm, 2 pads

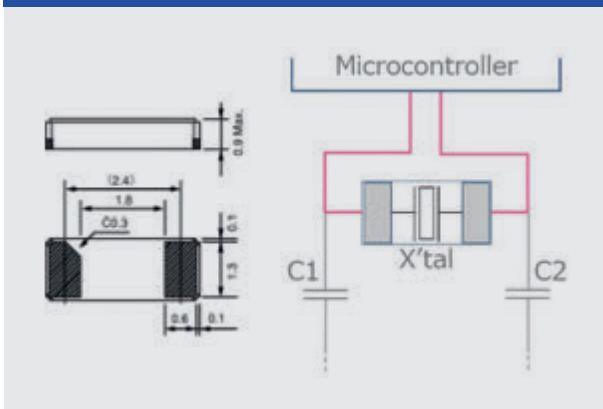

CM315E – 3.2 x 1.5 mm, 3 pads

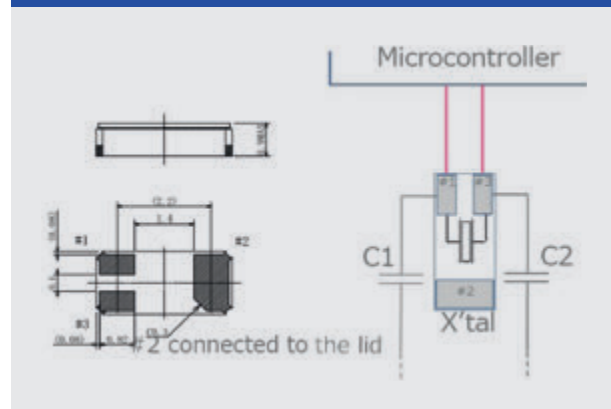

EMBEDDED COMPUTER (PANEL-PC)



The Logic Technology Group was formed in 2008. Headquartered in Hong Kong with offices in Baar, Switzerland and Shenzhen, China specialise in designing, development and manufacturing of Embedded Computer Solutions under the DLOGIC brand. DLOGIC focuses on Closed and Open Embedded Computer Solutions starting from sizes of 4.3"

up to 15.0". Available without Touch, with resistive as well as capacitive Touch. The multi-layer optical bonding technology provides cover lens thickness of 4 mm and UL 751 S46B certification. The Embedded Platforms are currently based on the two different processor cores, Freescale (NXP) ARM Cortex A8, iMX537 and ARM9, iMX257.

Board DL-PM53 (x-Version)

- Freescale i.MX537 (ARM Cortex A8)
- Memory DDR3: 1 GB
- eMMC Flash: 8 GB
- Boot: SPI Flash 2 MB
- HW Real-time Clock

Board DL-PM25 (i-Version)

- Freescale i.MX257 (ARM9)
- Memory DDR2: 128 MB
- NAND Flash: MLC 2 GB
- Boot: SPI Flash 2 MB
- HW Real-time Clock

The boards are equipped with the following interfaces:

- USB2.0
- Ethernet
- MicroSD
- Galvanic isolated CAN-Bus
- 2x Serial
- I²C
- PWM
- GPIO

Logic Technologie garantiert eine Lieferverfügbarkeit von 7 Jahren für alle DLOGIC Panel-PCs.

EMBEDDED COMPUTER (PANEL-PC)

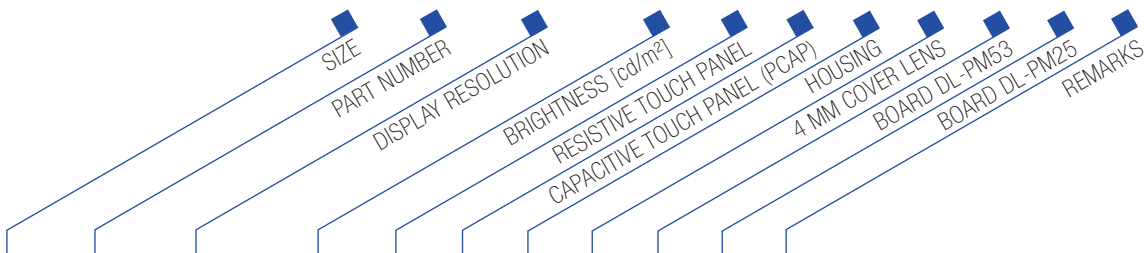

EMBEDDED COMPUTER (PANEL-PC) 4.3" - 15.0"

SIZE	PART NUMBER	DISPLAY RESOLUTION	BRIGHTNESS [cd/m ²]	RESISTIVE TOUCH PANEL	CAPACITIVE TOUCH PANEL (PCAP)	HOUSING	4 MM COVER LENS	BOARD DL-PM53	BOARD DL-PM25	REMARKS
4.3"	100934	480 x 272	550	•		•				• Ultra-Wide Angle, 4-Wire Touch
4.3"	100950	480 x 272	550			•				• Ultra-Wide Angle
5.0"	100933	800 x 480	550	•		•				• Ultra-Wide Angle, 4-Wire Touch
5.0"	101186	800 x 480	550			•			•	Ultra-Wide Angle
5.0"	100828	800 x 480	550			•				• Ultra-Wide Angle
5.0"	101314	800 x 480	550			•		•	•	Ultra-Wide Angle
5.0"	100831	800 x 480	550			•		•		• Ultra-Wide Angle
7.0"	100871	800 x 480	550			•		•	•	Ultra-Wide Angle
7.0"	100832	800 x 480	550			•		•		• Ultra-Wide Angle
7.0"	100870	800 x 480	550			•			•	Ultra-Wide Angle
7.0"	100829	800 x 480	550			•				• Ultra-Wide Angle
7.0"	101259	800 x 480	550	•		•		•		Ultra-Wide Angle, 4-Wire Touch
7.0"	100834	800 x 480	550	•		•				• Ultra-Wide Angle, 4-Wire Touch
9.0"	101072	800 x 480	550			•			•	Ultra-Wide Angle
9.0"	101069	800 x 480	550			•				• Ultra-Wide Angle
10.1"	100833	1280 x 800	550			•		•	•	IPS
10.1"	100830	1280 x 800	550			•			•	IPS
10.1"	101258	1280 x 800	550	•		•		•		IPS, 4-Wire Touch
10.4"	100932	800 x 600	350	•		•				• 4-Wire Touch
15.0"	100835	1024 x 768	400	•		•		•		5-Wire Touch



*Embedded Computer
with 4 mm Cover Lens*

EMBEDDED COMPUTER (PANEL-PC)

Reference drawing of a 10.1" Panel-PC

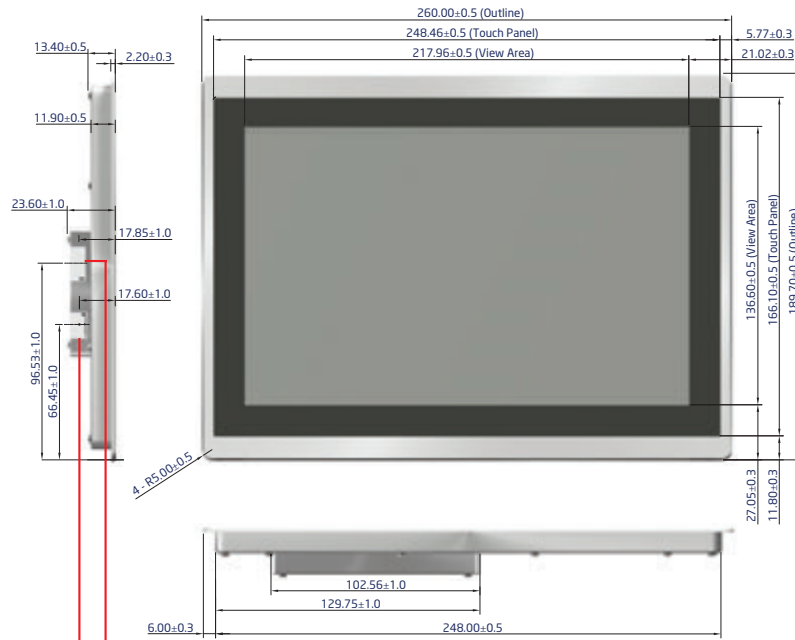

Secure locking connector 10~30Vdc

Secure locking connector RS-232/I2C/CAN/MDb/SPI/PWM/GPIOs/SPDIF/3.3V

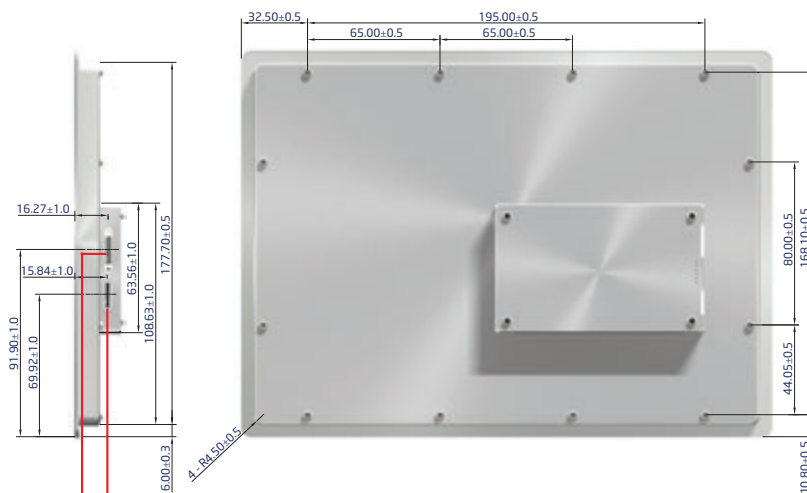

Micro SDHC

Screwlocked connector Ethernet/USB

Patented IP housing for the Closed Embedded Computer Solutions

EMBEDDED COMPUTER (PANEL-PC)

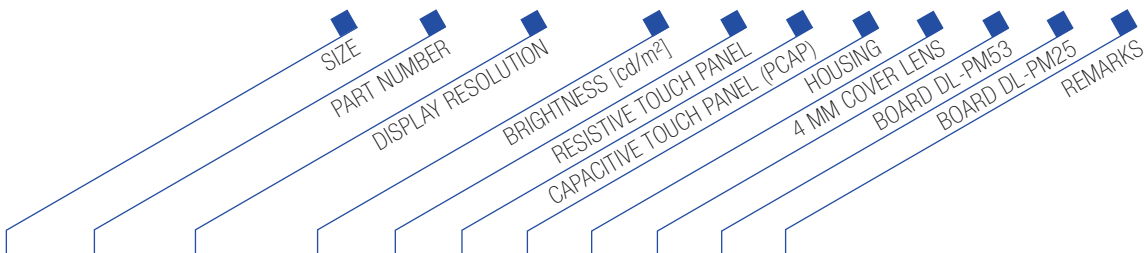

EMBEDDED COMPUTER (PANEL-PC) EVAL-KITS 4.3" - 15.0"

SIZE	PART NUMBER	DISPLAY RESOLUTION	BRIGHTNESS [cd/m ²]	RESISTIVE TOUCH PANEL	CAPACITIVE TOUCH PANEL (PCAP)	HOUSING	4 MM COVER LENS	BOARD DL-PM53	BOARD DL-PM25	REMARKS
4.3"	100945	480 x 272	550		•	•				• Ultra-Wide Angle
4.3"	100961	480 x 272	550	•		•				• Ultra-Wide Angle, 4-Wire Touch
5.0"	100962	800 x 480	550	•		•				• Ultra-Wide Angle, 4-Wire Touch
5.0"	101185	800 x 480	550		•	•		•		Ultra-Wide Angle
5.0"	100946	800 x 480	550		•	•				• Ultra-Wide Angle
7.0"	100948	800 x 480	550		•	•		•		Ultra-Wide Angle
7.0"	100947	800 x 480	550		•	•				• Ultra-Wide Angle
7.0"	100963	800 x 480	550	•		•				• Ultra-Wide Angle, 4-Wire Touch
7.0"	101279	800 x 480	550		•					• Ultra-Wide Angle
9.0"	101074	800 x 480	550		•	•		•		Ultra-Wide Angle
9.0"	101073	800 x 480	550		•	•				• Ultra-Wide Angle
10.1"	100949	1280 x 800	550		•	•		•		IPS
10.4"	100964	800 x 600	350	•		•				• 4-Wire Touch
15.0"	100965	1024 x 768	400	•		•		•		5-Wire Touch



Developer Kit accessories are Power Supply, Power Cable, 20-pin Interface Cable, DL-CB5 Developer Interface Board, USB & Ethernet Interface Cable

GIGADEVICE GD32 MCU

GD32 MCU Road map

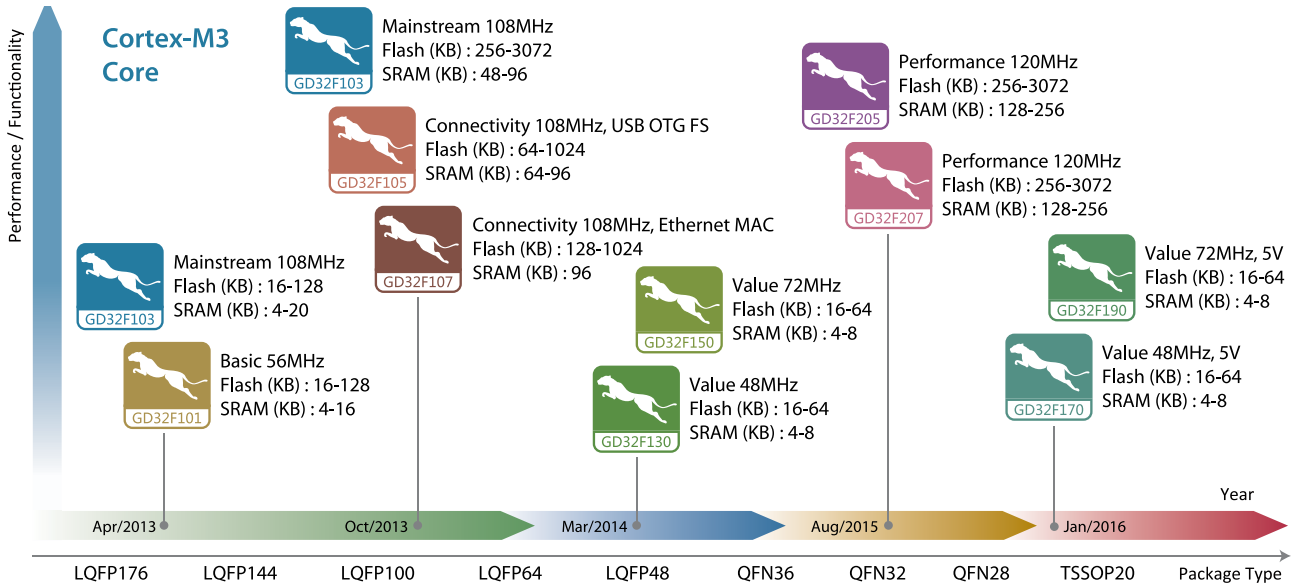

GD32 MCU Configuration

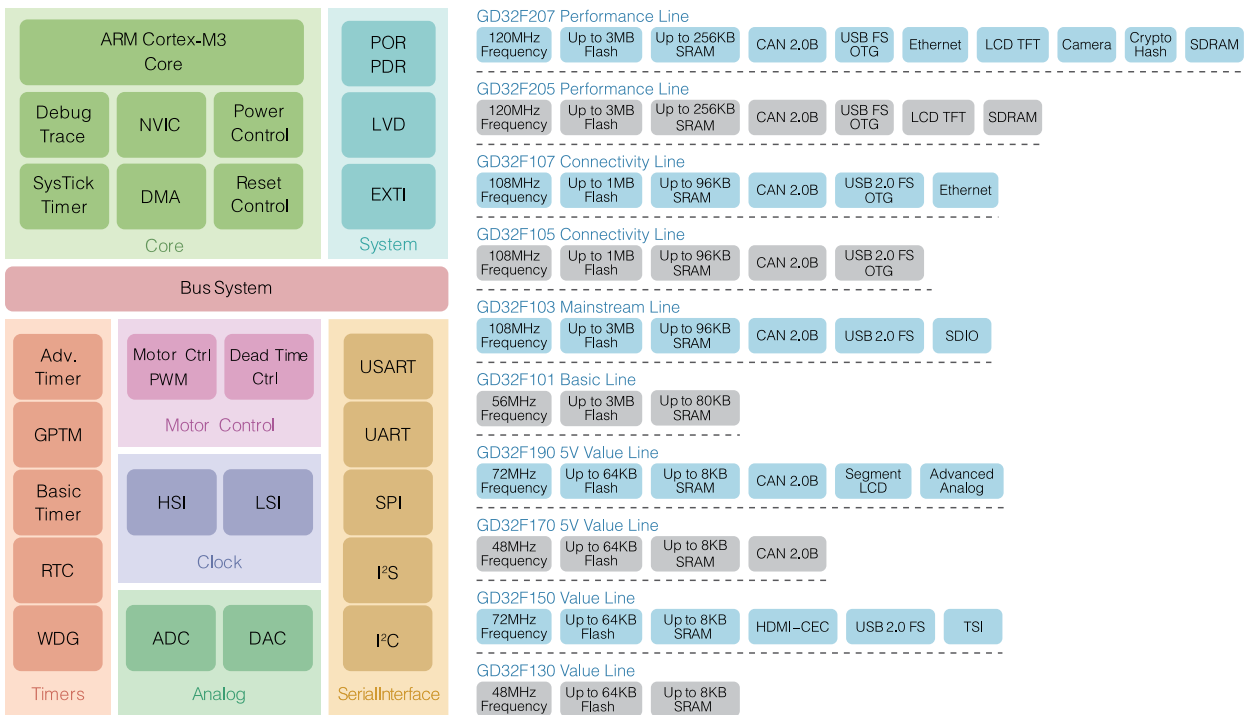

GIGADEVICE GD32 MCU

Corporate Snapshot

- Corporate Headquarters Beijing, China.
- Fabless semiconductor company focused on advanced memory and 32 Bit ARM based Microcontroller solutions.
- Over 1 Billion Flash devices shipped per year and growing.
- One of the widest NOR Flash product lines in the industry.
- Ranked 3rd WW for SPI NOR flash and growing.
- 1st supplier to ship 8-pin WSON8 (6 x 8 mm) SPI NAND Flash.
- Privately held company with plans to go public in 2016.
- 300 + employees with 55% focused on R&D.
- Blue Chip Customer base

Advanced Main Features

ARM® Cortex® -M3 Core

- Frequency up to 108 MHz
- Flash access zero wait state
- Single-cycle multiplier and hardware divider
- NVIC support 16 internal & 60 external interrupts, each has 16 priority levels

Memories

- Flash up to 3072 KByte
- SRAM up to 96 KByte
- 2-18KB ISP loader ROM

Low power management

- Power saving mode: sleep, deepsleep & standby mode
- Independent battery supply for RTC and backup register

Advanced analog peripherals

- 3 x 12bit, 1µs ADC (up to 21 chs)
- 2 x 12-bit DAC

Integrated peripherals interface

- Up to 5 x USART/UART/Irda/LIN/ISO7816
- Up to 3 x SPI (18Mbit/s), 2 x I2S multiplexed
- Up to 2 x I2C (400Kbit/s)
- Up to 2 x CAN 2.0 B (1Mbit/s)
- USB 2.0 FS device/host/OTG (12Mbit/s)
- SDIO
- 10/100 Ethernet MAC

On-chip resources

- 2 x Advanced Timer, 1 x SysTick Timer, up to 10 x GPTM, 2 x Basic Timer, 2 x WDG
- 12-chs DMA support: Timers, ADCs, DACs,
- SPIs, I2Ss, I2Cs, USARTs
- System supervisor and reset: POR, PDR, LVD
- 80% GPIO available
- 32-bit CRC & 96-bit unique ID
- On-chip clock: HSI (8MHz), LSI (40KHz)
- 8/16 bit External Memory Control supported: SRAM, PSRAM, NOR, NAND, LCD

Contact for information: Mr. Kinn · Tel. +49(0)7452-6007-21 · e-mail: d.kinn@endrich.com

ZENTRALE

ENDRICH Bauelemente Vertriebs GmbH · P.O.Box 1251 · D-72192 Nagold
 T +49 (0) 7452 6007-0 · F +49 (0) 7452 6007-70
 endrich@endrich.com · www.endrich.com

VERTRIEBSBÜROS IN EUROPA

Frankreich:

Paris: T +33/2 41 80 19 87 · france@endrich.com

Österreich & Slowenien

Wien: T +43/1 66 52 52 521 · austria@endrich.com

Ungarn:

Budapest: T +361 / 2 97 41 91 · hungary@endrich.com



Zertifiziert nach ISO 9001/14001

Bulgarien:

Sofia: T +359/2 874 30 49 · bulgaria@endrich.com

Rumänien:

Timisoara: T +40/356 11 41 88 · romania@endrich.com

Schweiz – Novitronic:

Zürich: T +41/44 306 91 91 · info@novitronic.ch

Spanien:

Barcelona: T +34/93 217 31 44 · spain@endrich.com