

Very Low Output Voltage Series Regulator

■ GENERAL DESCRIPTION

The NJM2847 is a series voltage regulator that delivers up to 150mA output current with the output voltage of 0.8 to 1.4V with ON/OFF control.

Advanced Bipolar technology achieves low noise, high ripple rejection, High accuracy and low quiescent current.

Small packaging and 2.2 μ F small decoupling capacitor make the NJM2847 suitable for space conscious applications.

■ PACKAGE OUTLINE

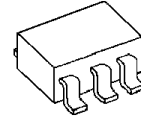

NJM2847F3

■ FEATURES

- Output Voltage Range 0.8V to 1.4V
- Input Voltage Range 2.3V to 9.0V
- High Ripple Rejection 85dB typ. (f=1kHz, V_O=0.8V version)
- Very Low Output Noise Voltage V_{NO}=20 μ Vrms typ. (C_p=0.01 μ F)
- Output Current I_O(max)=150mA
- High Precision Output V_O \pm 1.0%
- Output Capacitor with 2.2 μ F ceramic capacitor
- ON/OFF Control
- Built-in Thermal Overload Protection and Short Circuit Current Limit Protection
- Bipolar Technology
- Package Outline SC-88A

■ PIN CONNECTION

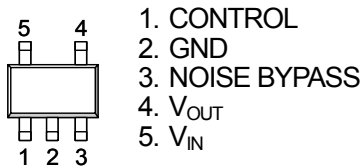

NJM2847F3

■ BLOCK DIAGRAM

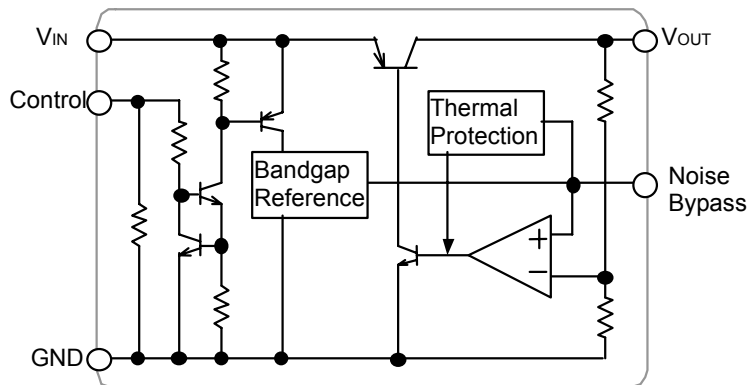

NJM2847

■ OUTPUT VOLTAGE RANK LIST

The WHITE column shows applicable Voltage Rank(s).

Device Name	V _{out}
NJM2847F3 -008	0.8V
NJM2847F3 -009	0.9V
NJM2847F3 -010	1.0V
NJM2847F3 -011	1.1V
NJM2847F3 -012	1.2V
NJM2847F3 -013	1.3V
NJM2847F3 -014	1.4V

Output Voltage Range: 0.8V to 1.4V (0.1V step)

■ ABSOLUTE MAXIMUM RATINGS (Ta=25°C)

PARAMETER	SYMBOL	RATINGS	UNIT
Input Voltage	V _{IN}	+10	V
Control Voltage	V _{CONT}	+10	V
Power Dissipation	P _D	250(*1)	mW
Operating Temperature	T _{opr}	-40 ~ +85	°C
Storage Temperature	T _{stg}	-40 ~ +125	°C

Note1: Mounted on glass epoxy board. (76.2 × 114.3 × 1.6mm:based on EIA/JDEC standard, 2Layers)

■ INPUT VOLTAGE RANGE

V_{IN}=+2.3 ~ +9V

■ ELECTRICAL CHARACTERISTICS (V_{IN}=2.5V, C_{IN}=0.1μF, C_o=2.2μF, C_p=0.01μF, Ta=25°C)

PARAMETER	SYMBOL	TEST CONDITION	MIN.	TYP.	MAX.	UNIT
Output Voltage	V _o	I _o =30mA	-1.0%	-	+1.0%	V
Input Voltage	V _{IN}		2.3	-	9	V
Quiescent Current	I _Q	I _o =0mA, except I _{cont}	-	140	200	μA
Quiescent Current at Control OFF	I _{Q(OFF)}	V _{CONT} =0V	-	-	100	nA
Output Current	I _o	V _o × 0.9V	150	200	-	mA
Line Regulation	ΔV _o /ΔV _{IN}	V _{IN} =2.5V to 9.0V, I _o =30mA	-	-	0.10	%/V
Load Regulation	ΔV _o /ΔI _o	I _o =0mA to 100mA	-	-	0.03	%/mA
Ripple Rejection	RR	e _{in} =200mVrms, f=1kHz, I _o =10mA, V _o =0.8V version	-	85	-	dB
Average Temperature Coefficient of Output Voltage	ΔV _o /ΔTa	Ta=0°C to +85°C, I _o =10mA	-	± 50	-	ppm/°C
Output Noise Voltage	V _{NO}	f=10Hz to 80kHz, I _o =10mA, V _o =0.8V version	-	20	-	μVrms
Control Current	I _{CONT}	V _{CONT} =1.6V	-	3	12	μA
Control Current for ON-state	V _{CONT(ON)}		1.6	-	-	V
Control Current for OFF-state	V _{CONT(OFF)}		-	-	0.6	V

The above specification is a common specification for all output voltages.

Therefore, it may be different from the individual specification for a specific output voltage.

TEST CIRCUIT

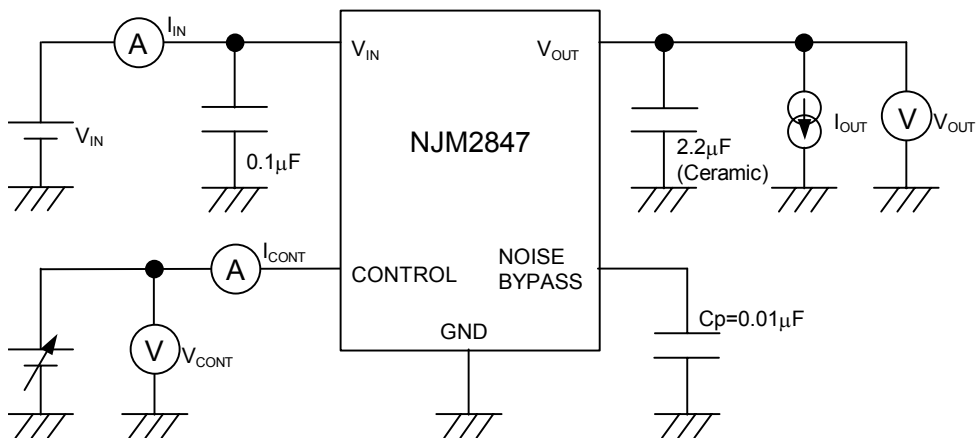

TYPICAL APPLICATION

a) In case of where ON/OFF control is not required:

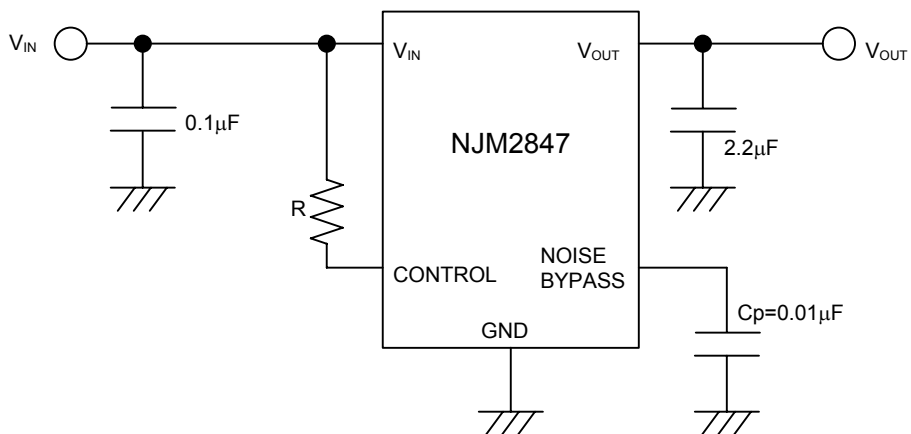

You shall connect control terminal to V_{IN} terminal.

Though the I_{CONT} decreases by inserting "R" to between Control terminal and V_{BIAS} terminal, the minimum operating voltage is increased due to the resistor "R".

NJM2847

b) In use of ON/OFF control:

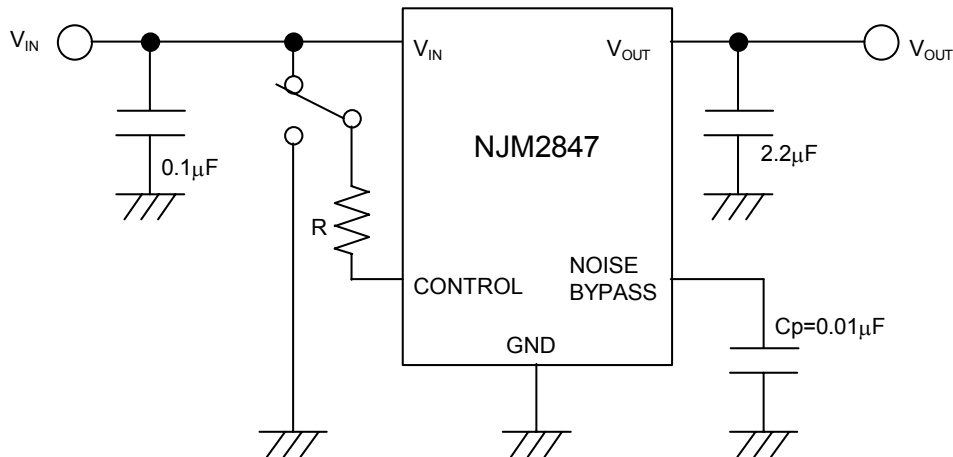

State of control terminal:

- “H”→ output is enabled.
- “L” or “open” → output is disabled.

*In the case of using a resistance "R" between V_{IN} and control.

If this resistor is inserted, it can reduce the control current when the control voltage is high.

The applied voltage to control terminal should set to consider voltage drop through the resistor "R" and the minimum control voltage for ON-state.

The $V_{CONT(ON)}$ and I_{CONT} have temperature dependence as shown in the "Control Current vs. Temperature" and "Control Voltage vs. Temperature" characteristics. Therefore, the resistance "R" should be selected to consider the temperature characteristics.

*Noise bypass Capacitor C_p

Noise bypass capacitor C_p reduces noise generated by band-gap reference circuit. Noise level and ripple rejection will be improved when larger C_p is used. Use of smaller C_p value may cause oscillation.

Use the C_p recommended value larger (refer to conditions of ELECTRIC CHARACTERISTIC) to avoid the problem.

*Input Capacitor C_{IN}

Input Capacitor C_{IN} is required to prevent oscillation and reduce power supply ripple for applications when high power supply impedance or a long power supply line.

Therefore, use the recommended C_{IN} value (refer to conditions of ELECTRIC CHARACTERISTIC) or larger and should connect between GND and V_{IN} as shortest path as possible to avoid the problem.

*Output Capacitor C_O

Output capacitor (C_O) will be required for a phase compensation of the internal error amplifier.

The capacitance and the equivalent series resistance (ESR) influence to stable operation of the regulator.

Use of a smaller C_O may cause excess output noise or oscillation of the regulator due to lack of the phase compensation.

On the other hand, Use of a larger C_O reduces output noise and ripple output, and also improves output transient response when rapid load change.

Therefore, use the recommended C_O value (refer to conditions of ELECTRIC CHARACTERISTIC) or larger and should connect between GND and V_{OUT} as shortest path as possible for stable operation

In addition, you should consider varied characteristics of capacitor (a frequency characteristic, a temperature characteristic, a DC bias characteristic and so on) and unevenness peculiar to a capacitor supplier enough.

When selecting C_O , recommend that have withstand voltage margin against output voltage and superior temperature characteristic though this product is designed stability works with wide range ESR of capacitor including low ESR products.

NJM2847

POWER DISSIPATION vs. AMBIENT TEMPERATURE(SC-88A)

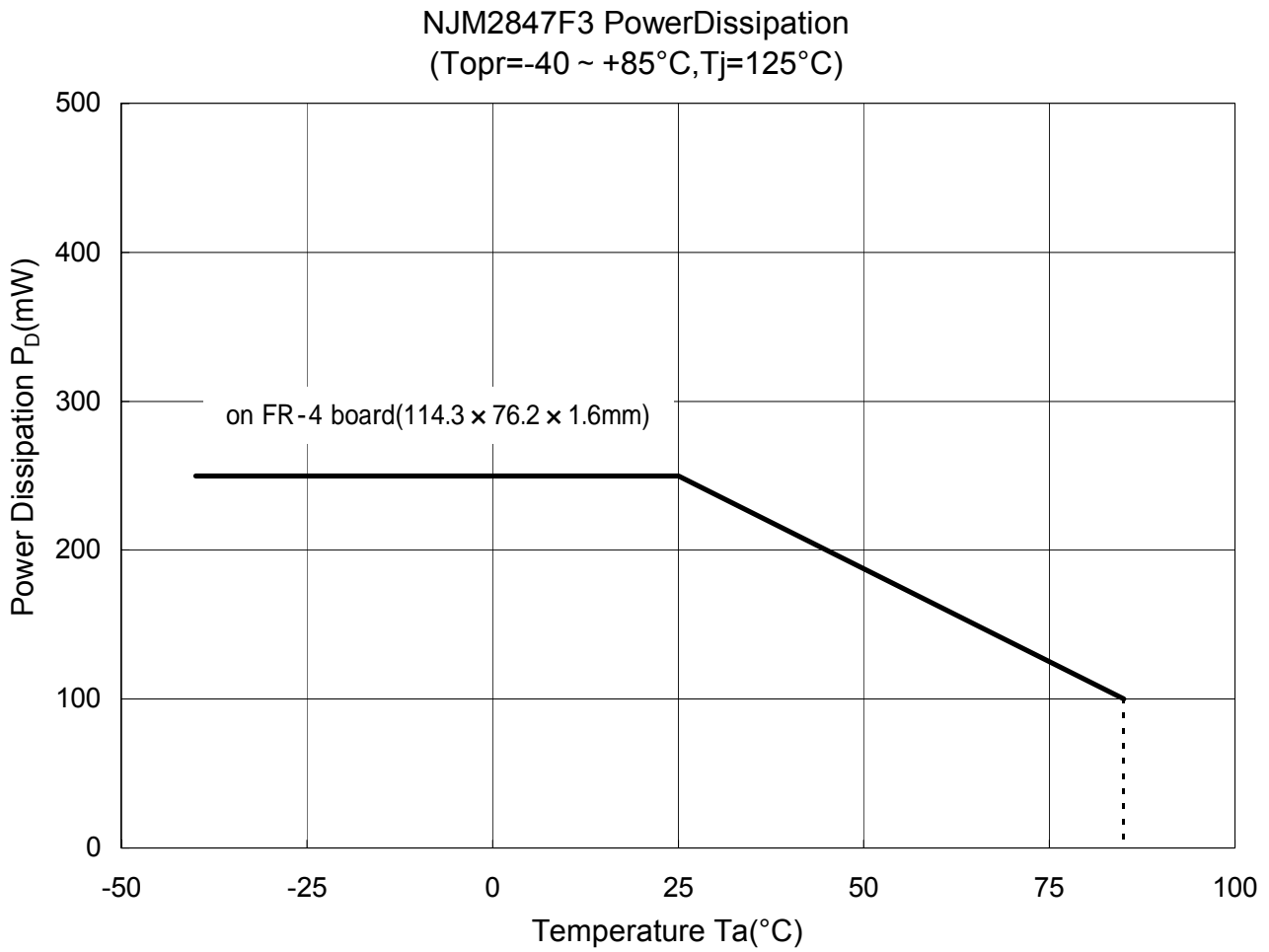

Typical Characteristics

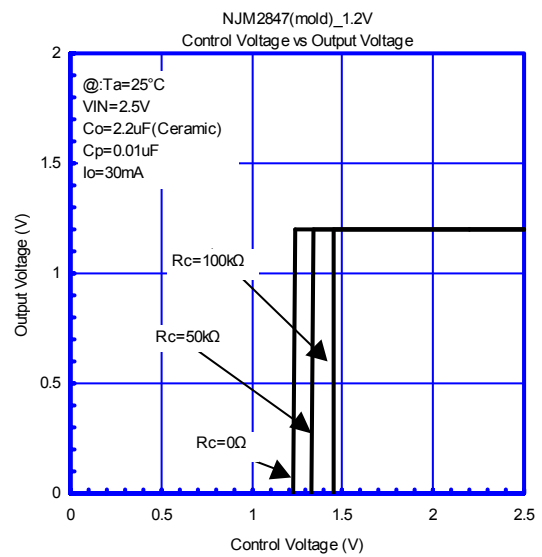
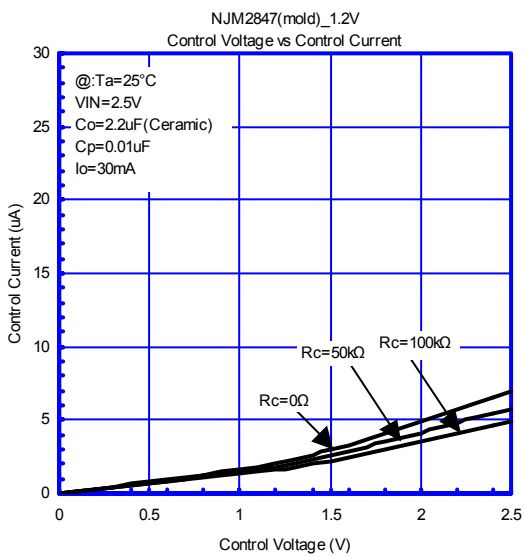
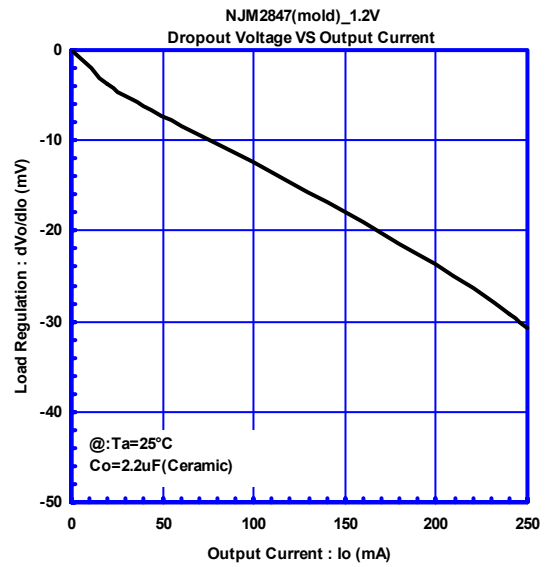
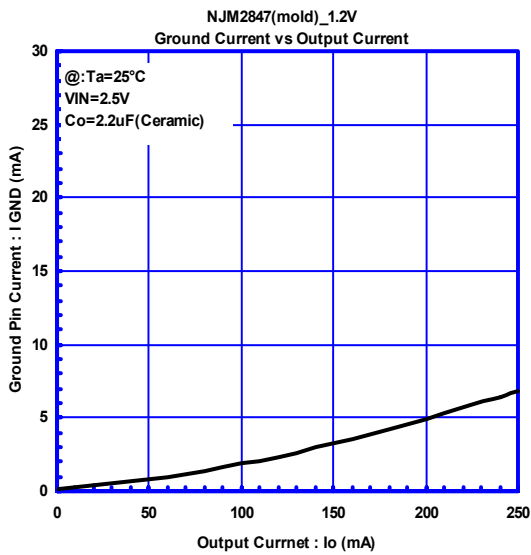
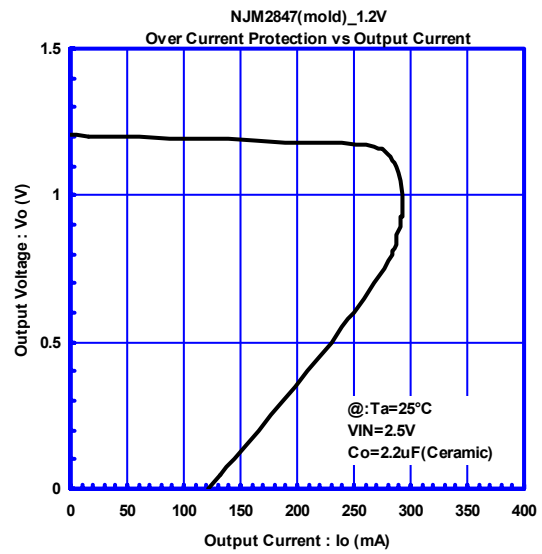
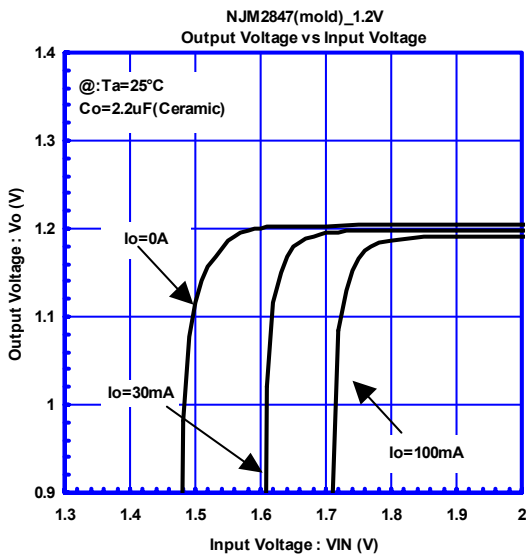

NJM2847

Typical Characteristics

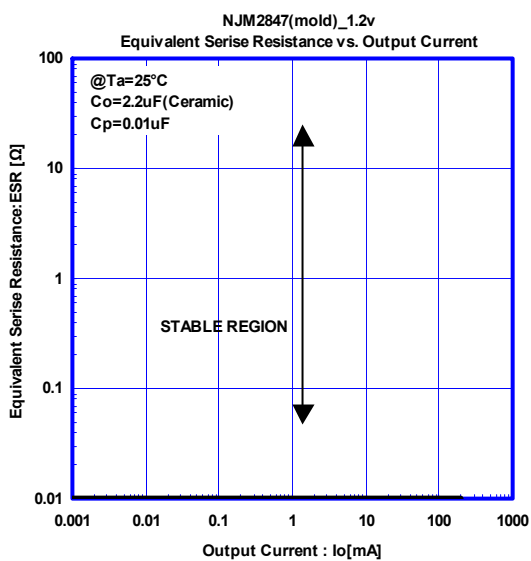
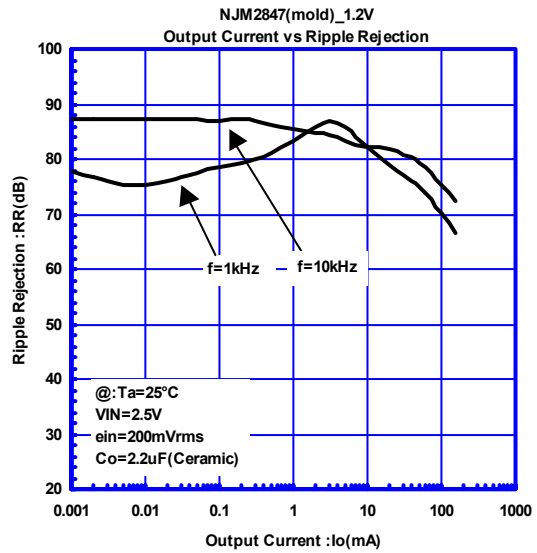
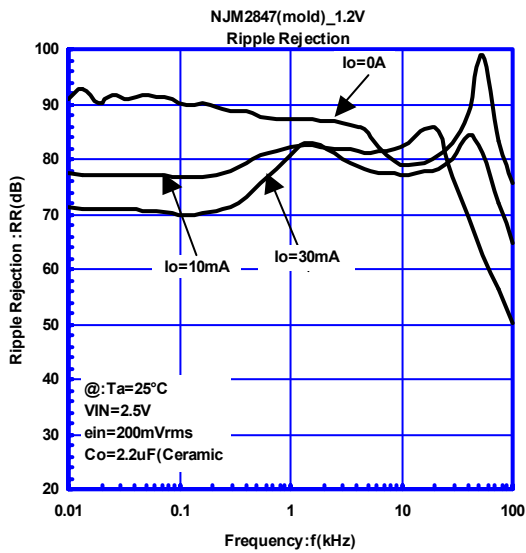
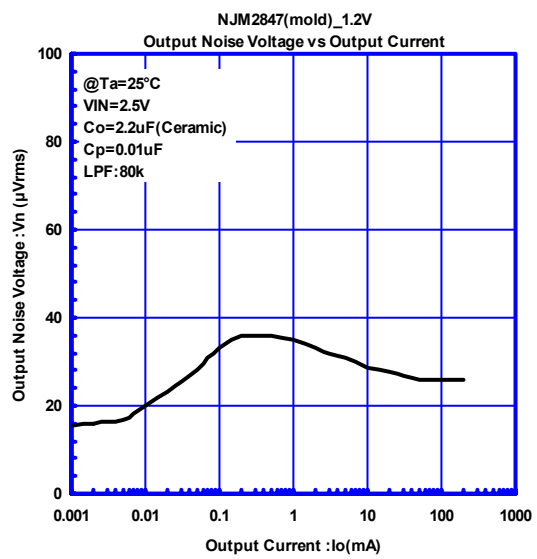
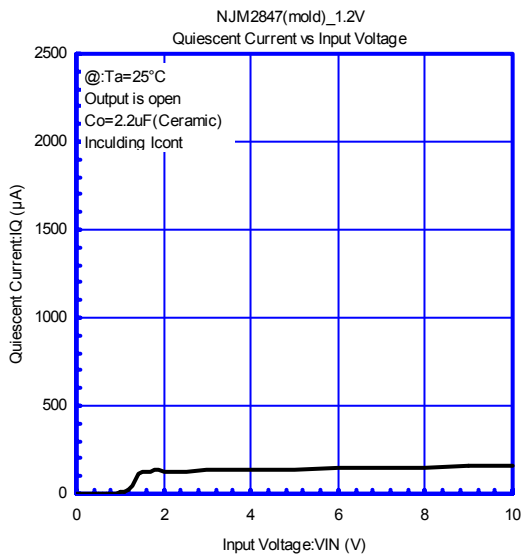

Typical Characteristics

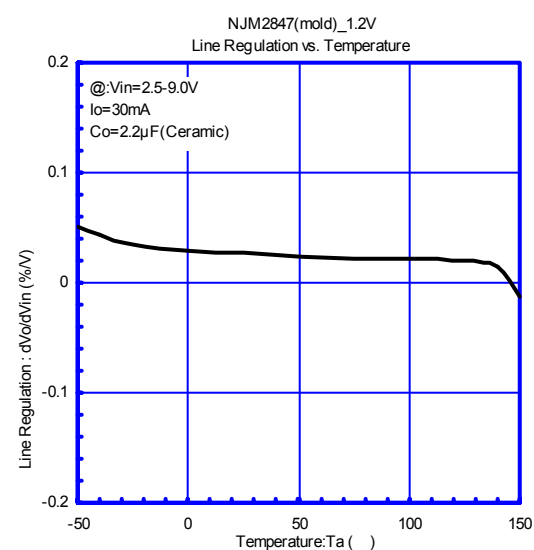
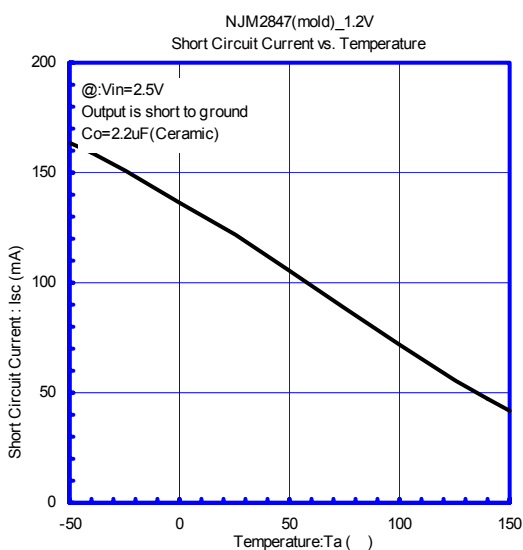
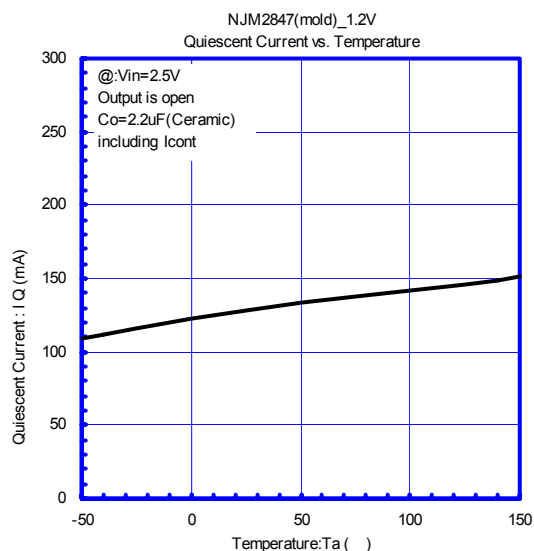
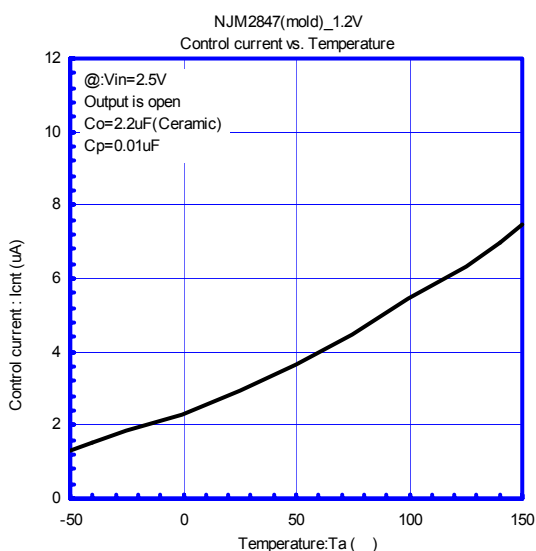
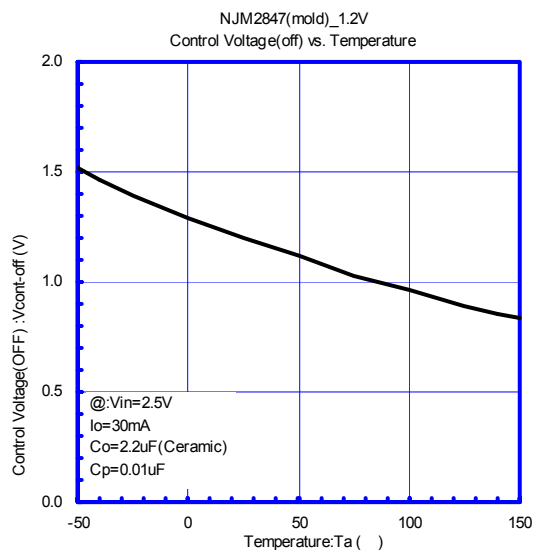
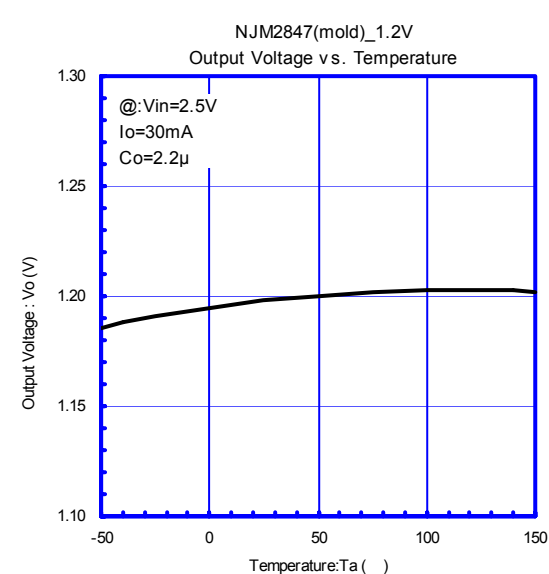

NJM2847

Typical Characteristics

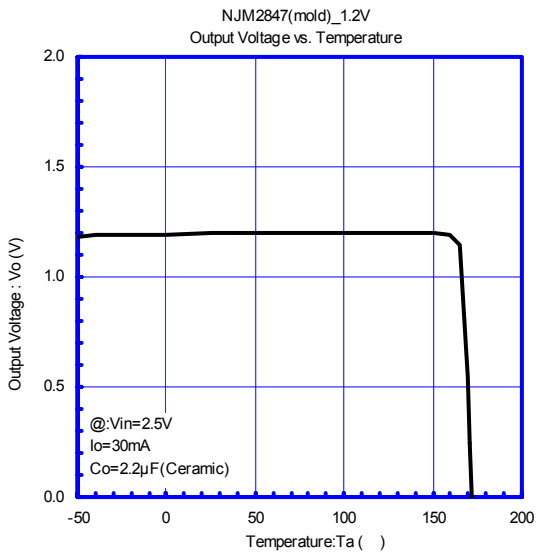
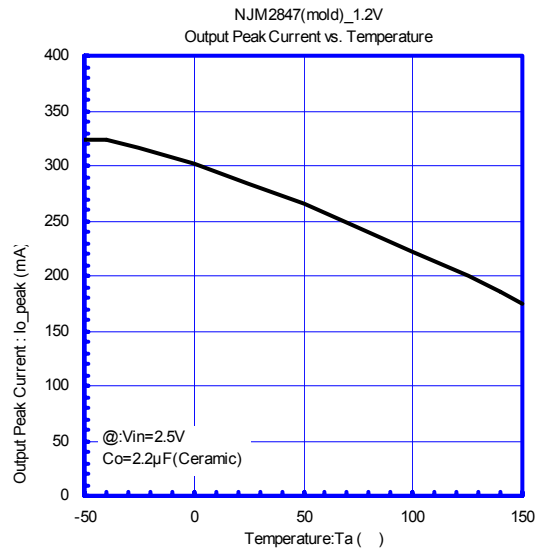
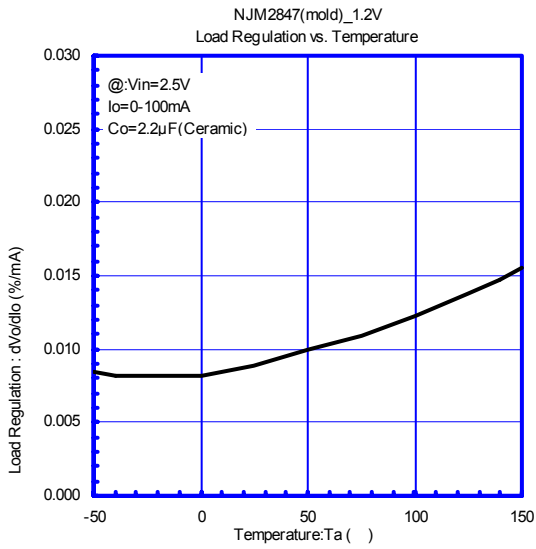

Typical Characteristics

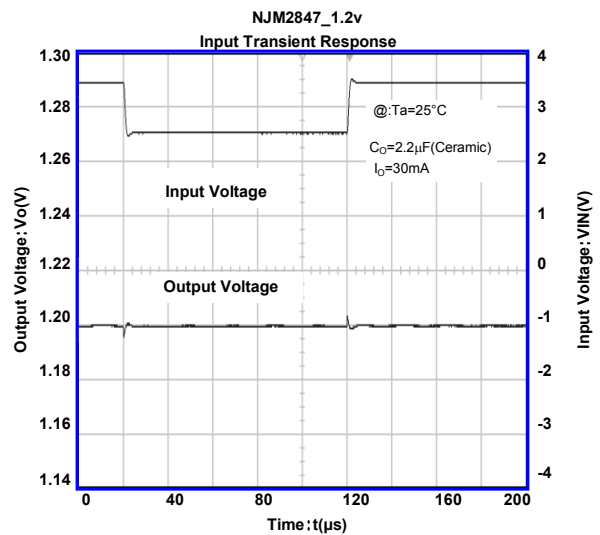
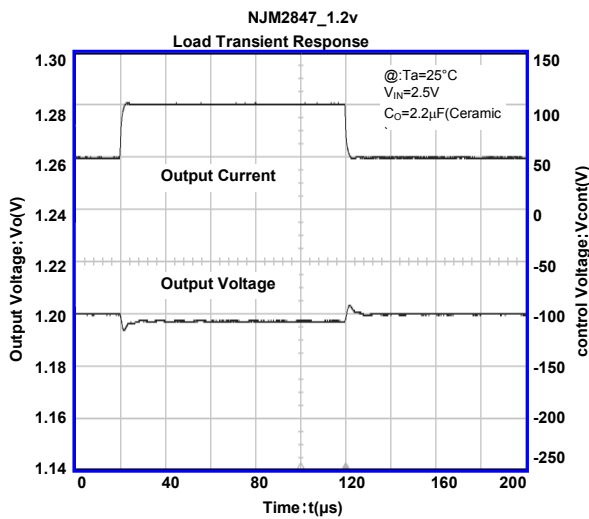
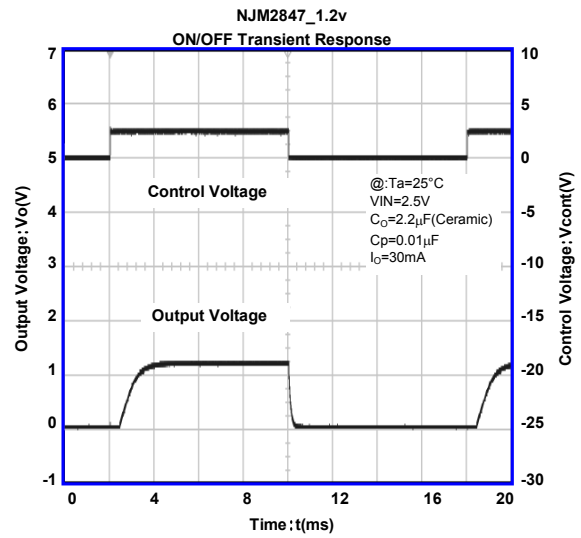
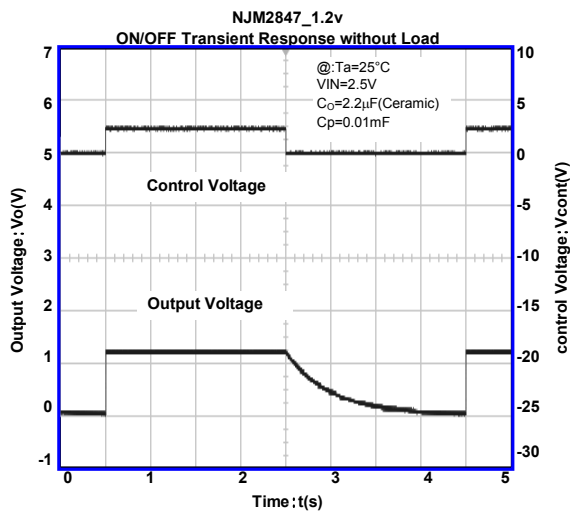

[CAUTION]

The specifications on this databook are only given for information, without any guarantee as regards either mistakes or omissions. The application circuits in this databook are described only to show representative usages of the product and not intended for the guarantee or permission of any right including the industrial rights.