

Low Dropout Voltage Regulator with Reset

■ GENERAL DISCRIPTION

The NJM2801 is a low dropout voltage regulator with reset function.

It provides up to 150mA of logic supply, and the reset function monitors output voltage of the regulator with 1% accuracy.

It is suitable for local power supply and reset for small micro controller and other logic chips.

■ PACKAGE OUTLINE

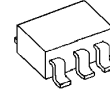

NJM2801F



NJM2801U/U1

■ FEATURES

- Output Voltage Accuracy $V_o = \pm 1.0\%$
- Reset Voltage Accuracy $V_{RT} = \pm 1.0\%$
- Adjust reset delay time with external capacitor.
- Ripple Rejection 60dB typ. (f=1kHz)
- Output Voltage Monitor type
- Open Collector Output
- Internal Short Circuit Current Limit
- Internal Thermal Overload Protection
- Bipolar Technology
- Package Outline SOT89-5 (NJM2801U/U1), SOT-23-5(NJU2801F)

■ PIN CONFIGURATION

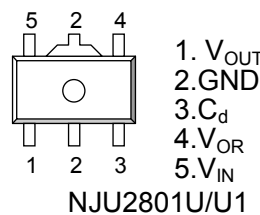
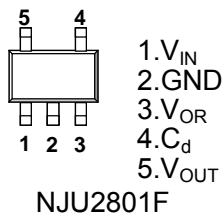

■ EQUIVALENT CIRCUIT

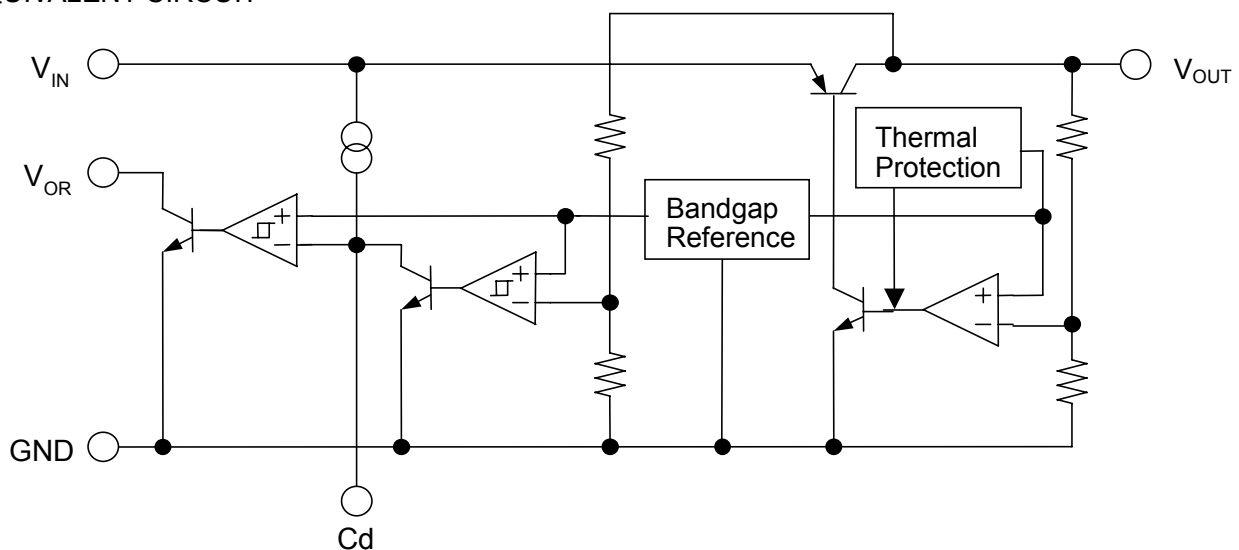

■ OUTPUT VOLTAGE/ DETECTION VOLTAGE

Device Name	Output Voltage	Detection Voltage
NJM2801U1-/U/F3328	3.3V	2.8V
NJM2801U1-/U/F0543	5.0V	4.3V

■ ABSOLUTE MAXIMUM RATINGS

(Ta=25°C)

PARAMETER	SYMBOL	RATINGS	UNIT
Input Voltage	V _{IN}	+14	V
Power Dissipation	P _D	SOT-23-5	350(*1)
			200(*2)
		SOT89-5	350(*2)
Operating Temperature	Topr	-40~+85	°C
Storage Temperature	Tstg	-40~+125	°C

(*1): Mounted on glass epoxy board based on EIA/JEDEC. (114.3x76.2x1.6mm: 2Layers)

(*2): Device itself.

■ ELECTRICAL CHARACTERISTICS (V_{IN}=V_o+1V, C_{IN}=0.1μF, C_o=1μF (V_o≤2.6V: C_o=2.2μF) Ta=25°C)

PARAMETER	SYMBOL	TEST CONDITION	MIN.	TYP.	MAX.	UNIT
Quiescent Current	I _Q	I _o =0mA	-	250	350	μA
Regulator Block						
Output Voltage	V _o	I _o =30mA	-1.0%	-	+1.0%	V
Output Current	I _o	V _o -0.3V	150	200	-	mA
Line Regulation	ΔV _o /ΔV _{IN}	V _{IN} =V _o +1V~V _o +6V, I _o =30mA	-	-	0.10	%/V
Load Regulation	ΔV _o /ΔI _o	I _o =0~100mA	-	-	0.03	%/mA
Dropout Voltage	ΔV _{L_O}	I _o =60mA	-	0.10	0.18	V
Ripple Rejection	RR	e _{in} =200mVrms, f=1kHz, I _o =10mA, V _o =3V	-	60	-	dB
Output Voltage Temperature Coefficient	ΔV _o /ΔT	Ta=0~85°C, I _o =10mA	-	±50	-	ppm/°C
Output Noise Voltage	V _{NO}	f=10Hz~100kHz, I _o =10mA, V _o =3V	-	45	-	μVrms
Reset Block						
Voltage Detection	V _{RT}	V _{IN} =H→L	-1.0%	-	+1.0%	V
Hysteresis Voltage	V _{RTH}	V _{IN} =H→L→H	V _{RT} ×3%	V _{RT} ×5%	V _{RT} ×8%	V
Low Level Output Voltage	R _{ORL}	V _{IN} =V _{RT} -0.5V, R _L =100kΩ	-	100	300	mV
Output Leak Current	I _{ORH}	V _{IN} =V _{RT} +0.5V	-	-	0.1	μA
On time Output Current	I _{ORL}	V _{IN} =V _{RT} -0.5V, R _L =0Ω	5	-	-	mA
Reset Output Delay Time	t _d	V _{IN} =(V _{RT} -0.5V)→(V _{RT} +0.5V), C _d =0.1μF	9	10	11	ms
Operation Voltage Limit	V _{OPL}	V _{ORL} =0.4V	-	0.9	-	V

The above specification is a common specification for all output voltages.

Therefore, it may be different from the individual specification for a specific output voltage.

■ TIMING CHART

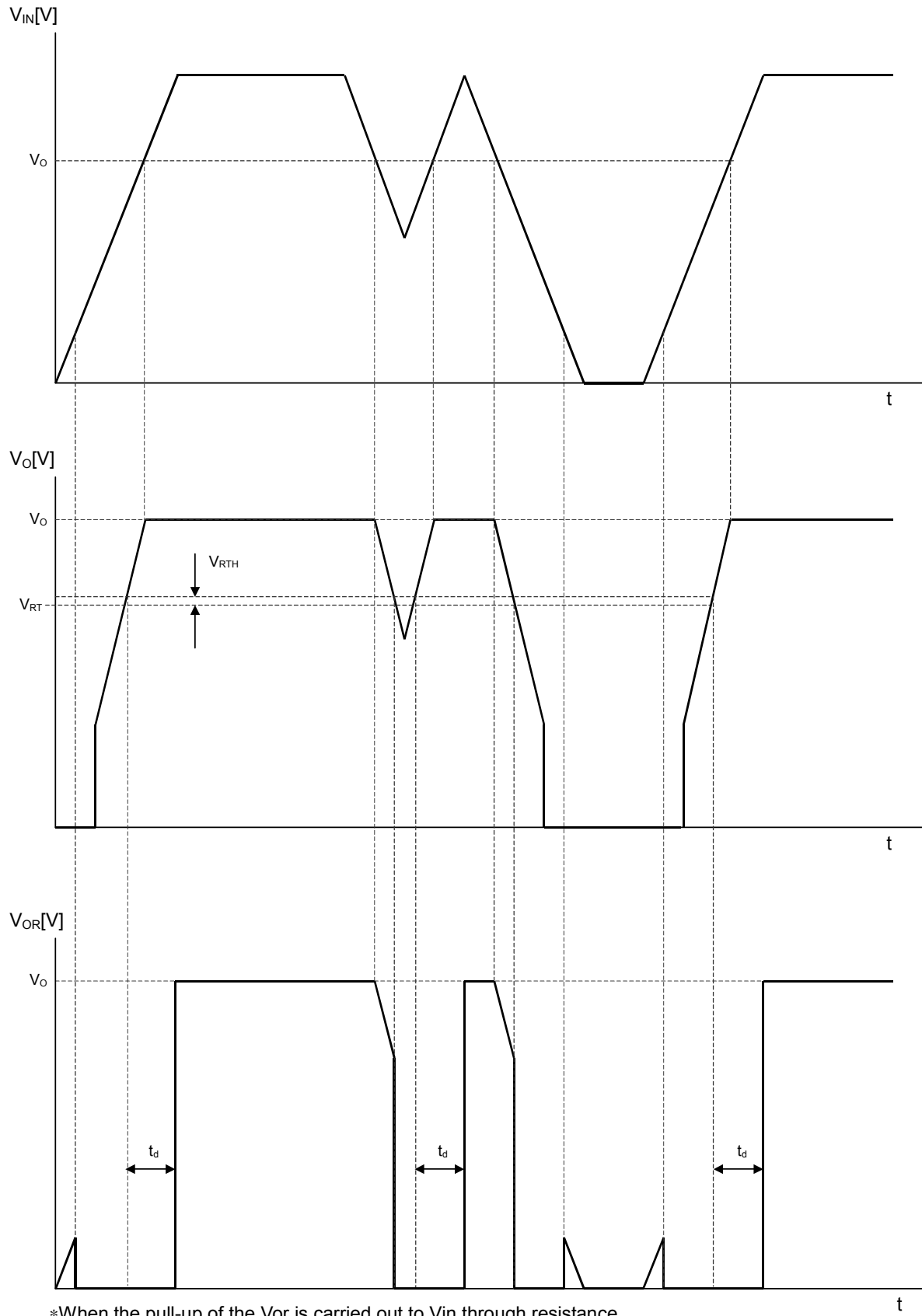

*When the pull-up of the Vor is carried out to Vin through resistance.

■ TEST CIRCUIT

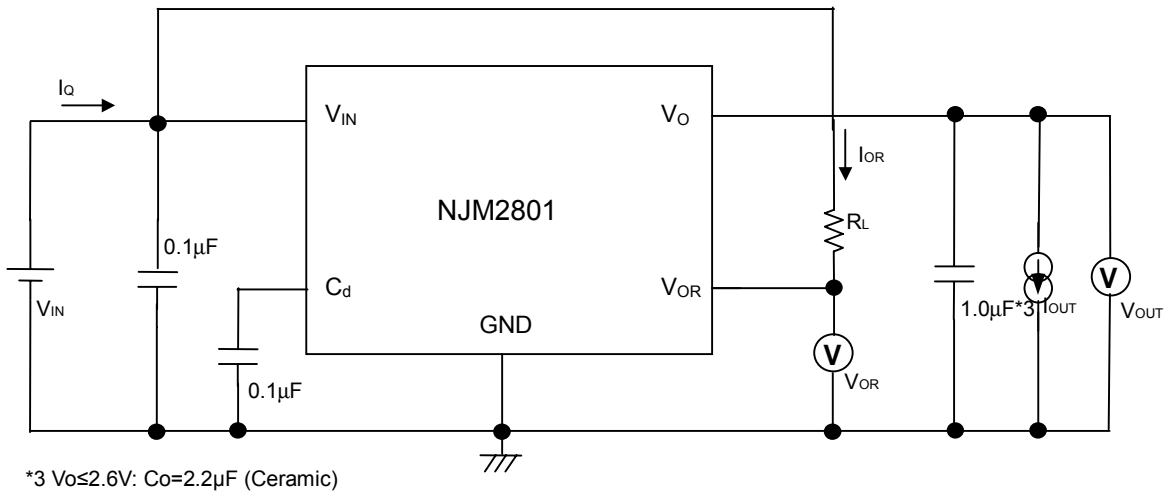

■ TYPICAL APPLICATIONS

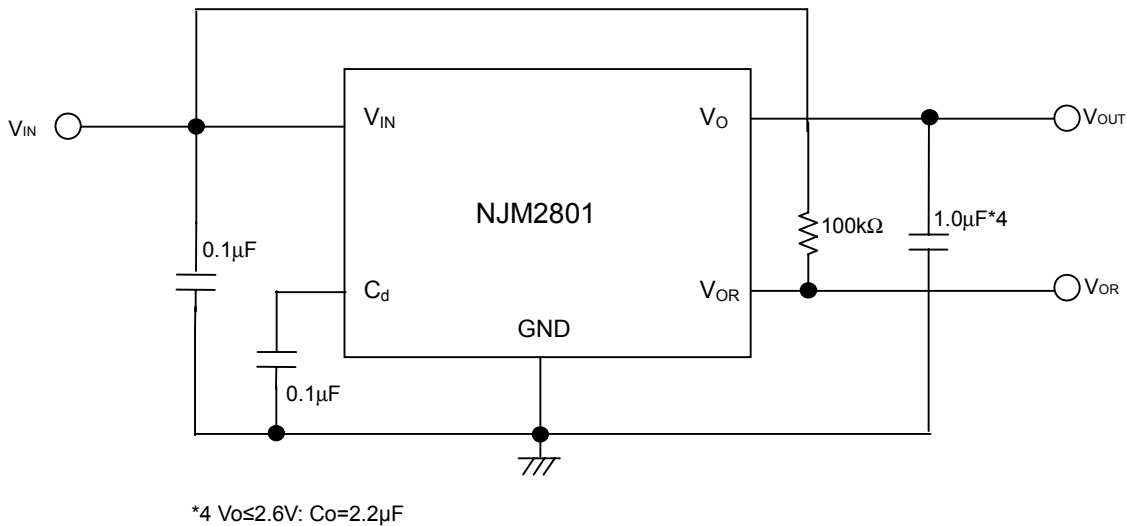

■ POWER DISSIPATION vs. AMBIENT TEMPERATURE

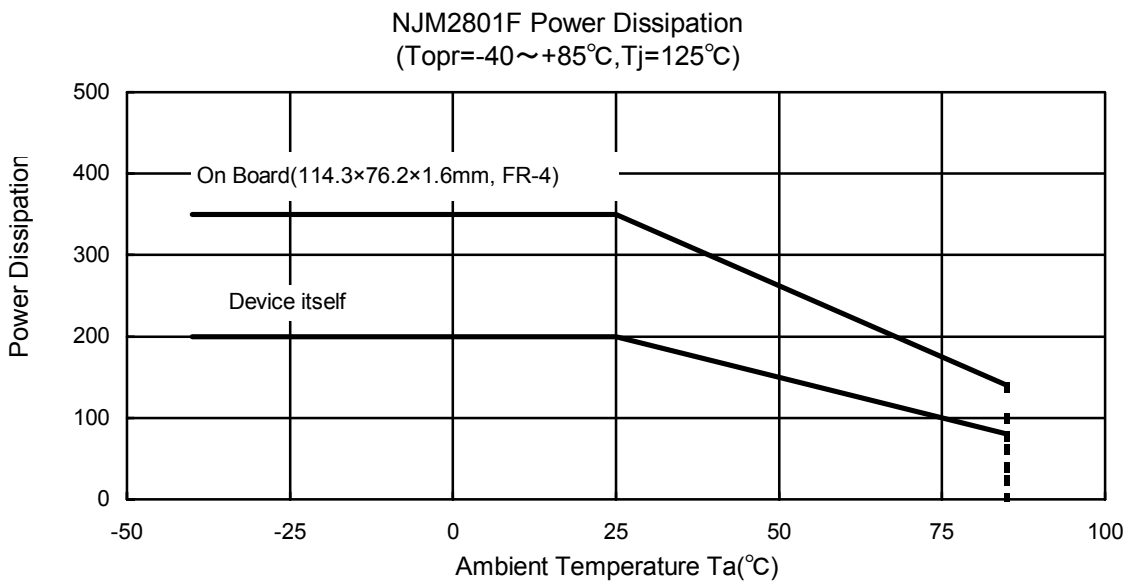

■ ELECTRICAL CHARACTERISTICS

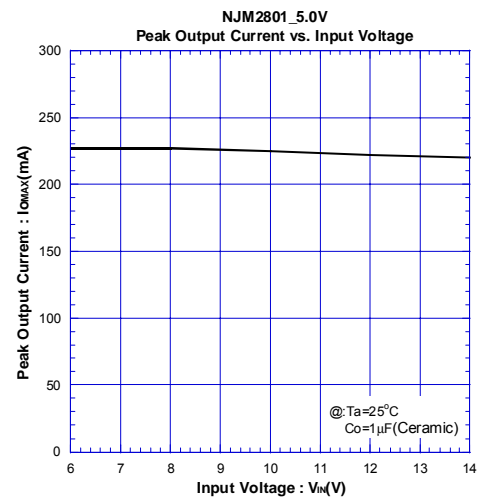
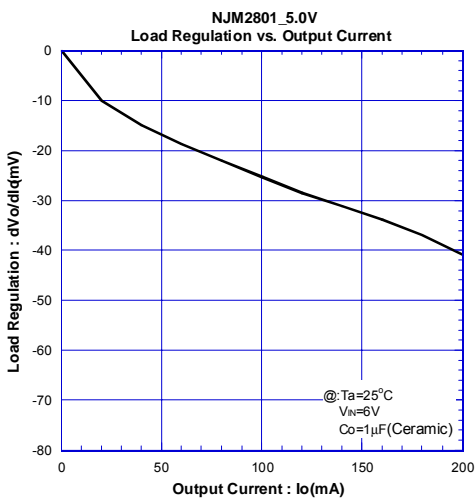
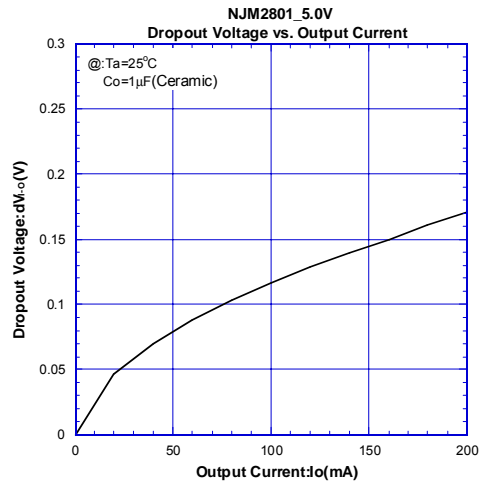
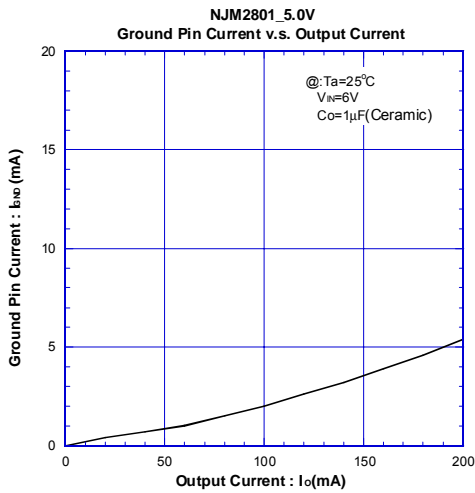
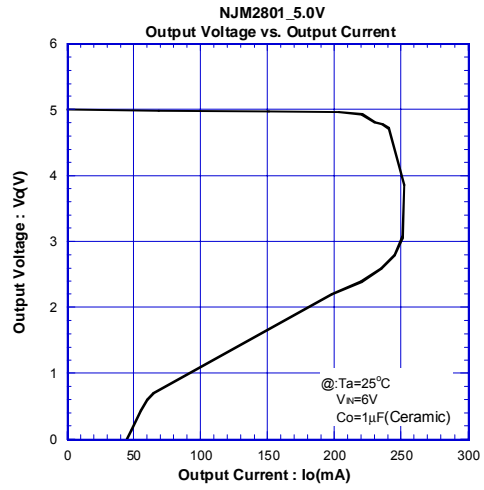
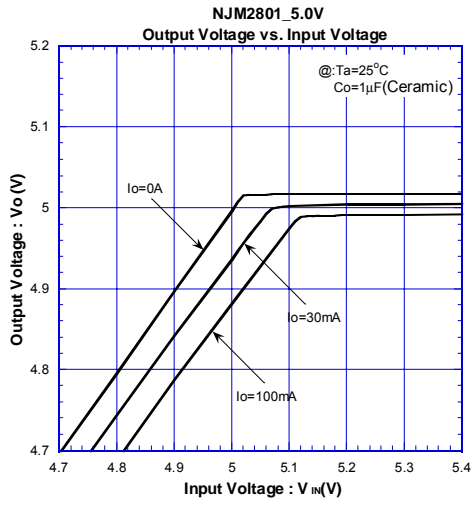

■ ELECTRICAL CHARACTERISTICS

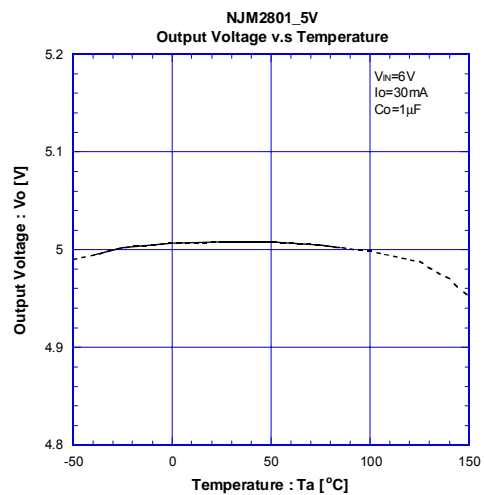
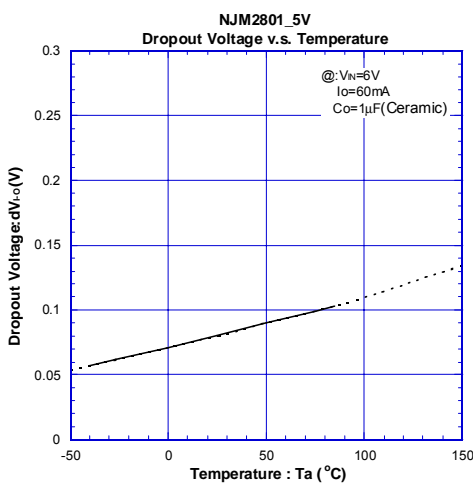
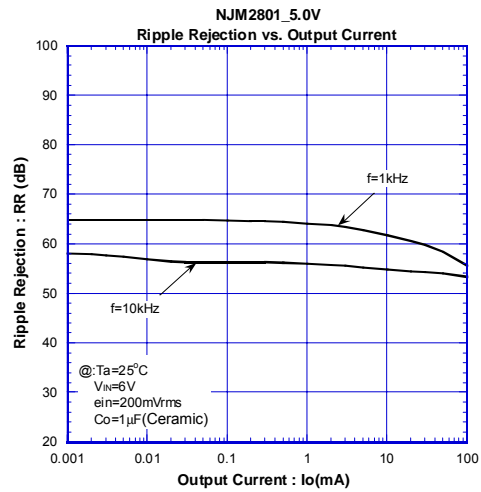
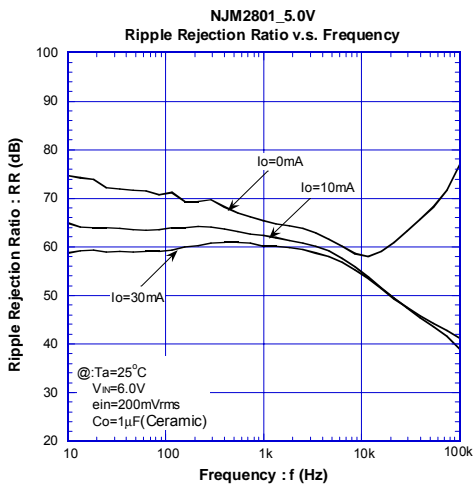
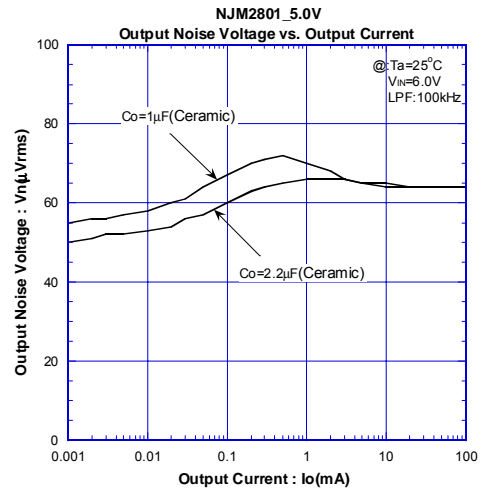
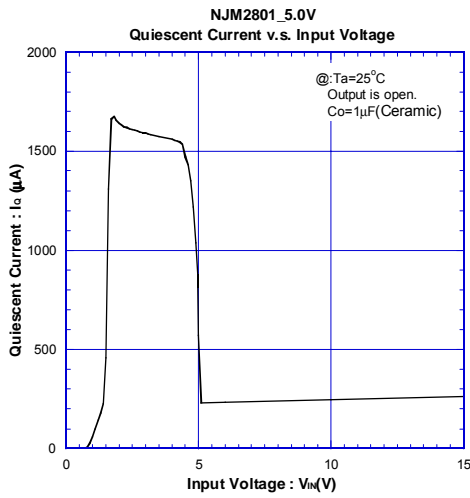

■ ELECTRICAL CHARACTERISTICS

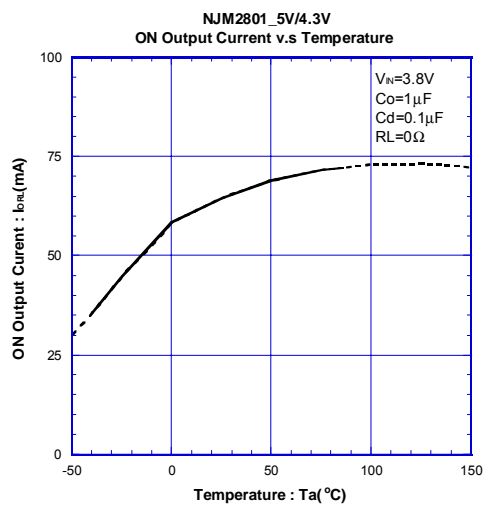
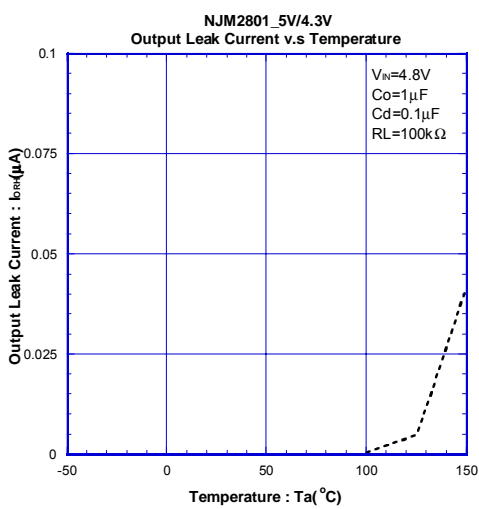
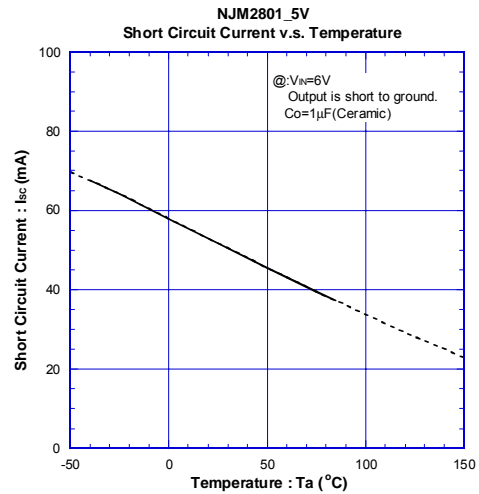
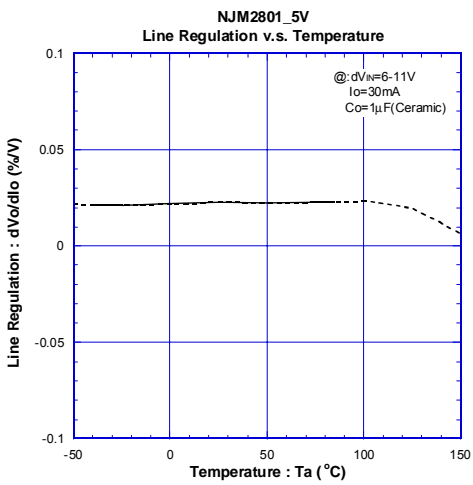
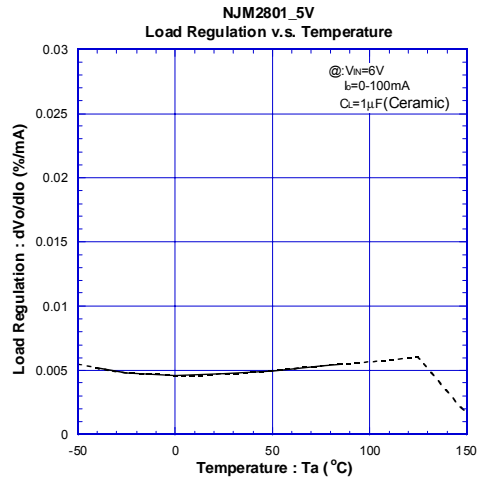
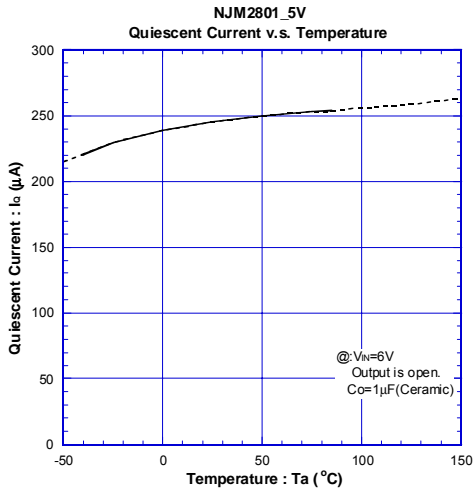

ELECTRICAL CHARACTERISTICS

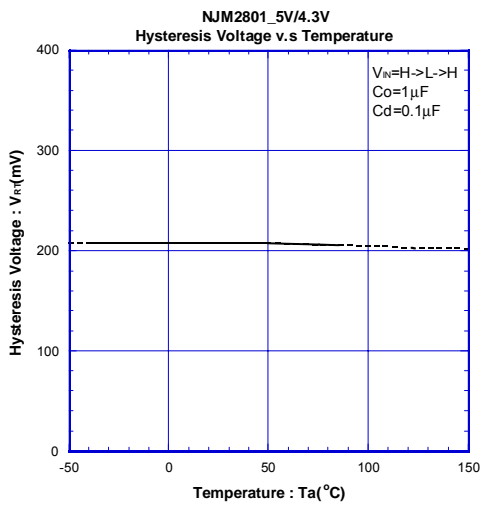
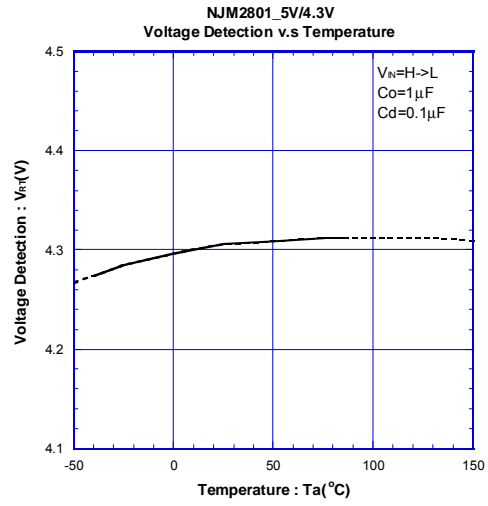
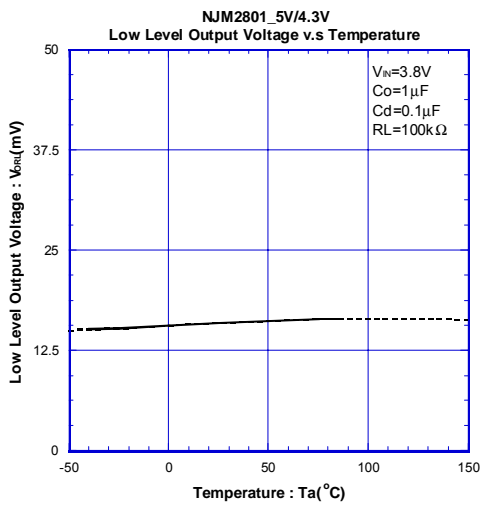
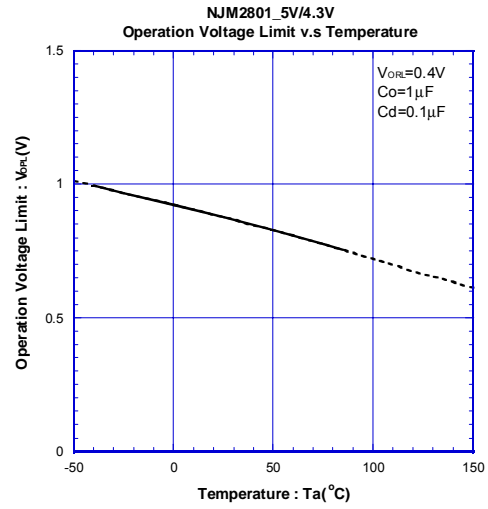
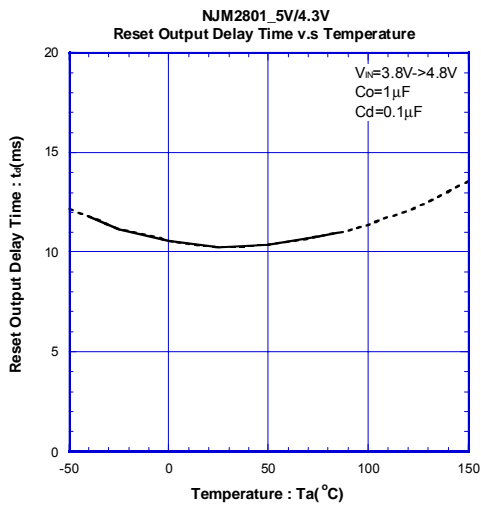

■ ELECTRICAL CHARACTERISTICS

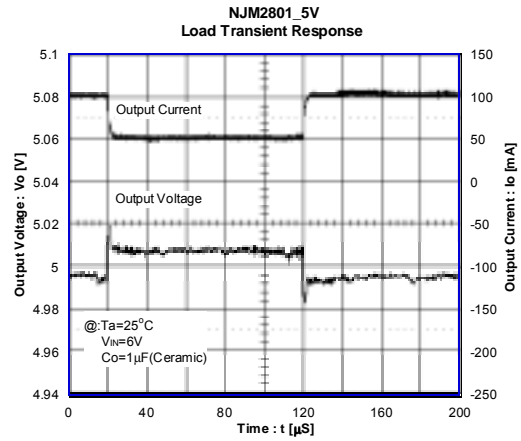
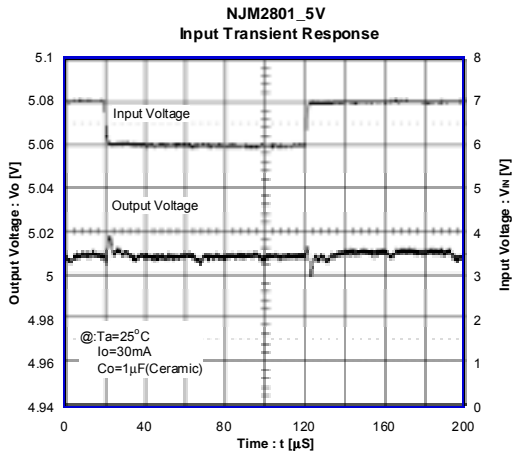

[CAUTION]

The specifications on this databook are only given for information, without any guarantee as regards either mistakes or omissions. The application circuits in this databook are described only to show representative usages of the product and not intended for the guarantee or permission of any right including the industrial rights.