

Dual Precision Operational Amplifier

FEATURES

- Precision $V_{IO}=60\mu\text{V max.}$
 $V_{IO}=100\mu\text{V max. (Ta=-40}^\circ\text{C to +85}^\circ\text{C)}$
- Low Offset Drift $\Delta V_{IO}/\Delta T=0.9\mu\text{V}/^\circ\text{C max. (Ta=-40}^\circ\text{C to +85}^\circ\text{C)}$
- Specified for $\pm 15\text{V}$ and $\pm 5\text{V}$ operation
- CMR 128dB min.
- Low Noise $V_{NI}=80\text{nVrms typ. at f=1 to 100Hz}$
 $e_n=8\text{nV}/\sqrt{\text{Hz typ. at f=100Hz}}$
- Open Loop Gain $A_v=130\text{dB min.}$
- Guaranteed Temperature $T_a=-40^\circ\text{C to +85}^\circ\text{C}$
- Unity Gain Stable
- Operating Voltage $V_{opr}=\pm 3\text{V to } \pm 18\text{V}$
- Unity Gain Frequency $f_T=1.1\text{MHz typ.}$
- Supply Current $I_{cc}=3.2\text{mA max.}$
- Package SOP8

PACKAGE OUTLINE

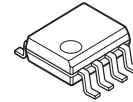

NJM2739E

GENERAL DESCRIPTION

The NJM2739 is a high performance operational amplifier featured very low offset voltage and drift.

Features are low offset voltage and drift, high common mode rejection, low noise and open loop gain. DC characteristics are 100% tested and specified from -40°C to 85°C .

The NJM2739 is suitable for high gain circuit amplified small signal and sets required stable behavior over a wide temperature range.

APPLICATION

- Thermocouple sensor
- Bridge Amplifier
- Current Sensor
- Instrumentation Amplifier
- Reference Voltage Circuit

PIN CONFIGURATION

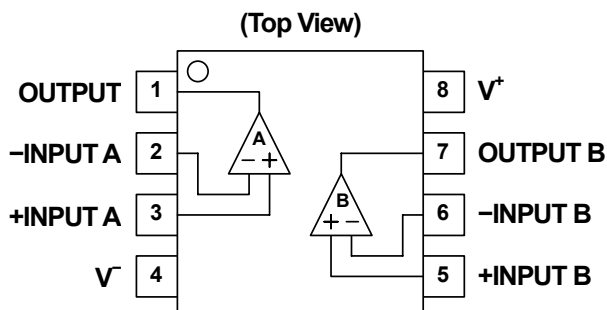

PACKAGE DESCRIPTION

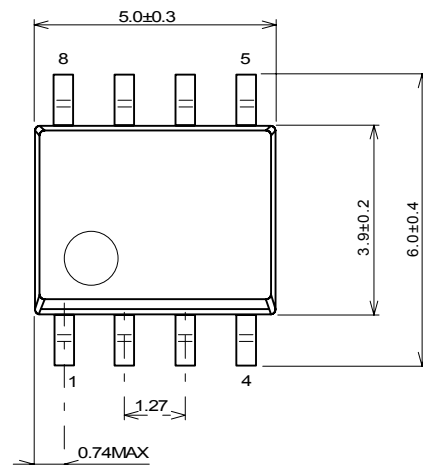

NJM2739

■ ABSOLUTE MAXIMUM RATING (Ta=25°C Unless Otherwise Specified)

PARAMETER	SYMBOL	RATING	UNIT
Supply Voltage	V ⁺ /V ⁻	±20	V
Common Mode Input Voltage Range (Note1)	V _{ICM}	±20	V
Differential Input Voltage Range	V _{ID}	±30	V
Power Dissipation (Note2)	P _D	640	mW
Operating Temperature Range	T _{opr}	-40 to +85	°C
Storage Temperature Range	T _{stg}	-50 to +125	°C

(Note1) For supply voltage less than ±20V, the maximum input voltage is equal to the supply voltage.

(Note2) Mounted on the EIA/JEDEC standard board (114.3×76.2×1.6mm, two layer, FR-4).

■ RECOMMENDED OPERATING VOLTAGE

PARAMETER	SYMBOL	TEST CONDITION	MIN.	TYP.	MAX.	UNIT
Supply Voltage	V ⁺ /V ⁻		±3	-	±18	V

■ ELECTRONIC CHARACTERISTICS (V⁺/V⁻=±15V Ta=+25°C, V_{CM}=0V unless otherwise specified)

● DC CHARACTERISTICS

PARAMETER	SYMBOL	TEST CONDITION	MIN.	TYP.	MAX.	UNIT
Input Characteristics						
Input Offset Voltage	V _{IO1}		-	20	60	μV
	V _{IO2}	Ta=-40 to +85°C	-	20	100	μV
Input Offset Voltage Drift	ΔV _{IO} /ΔT	Ta=-40→+25°C / Ta=+25°C→+85°C	-	0.3	0.9	μV/°C
Common Mode Input Voltage Range	V _{ICM1}		±13	±14	-	V
	V _{ICM1}	Ta=-40 to +85°C	±13	±13.5	-	dB
Common Mode Rejection Ratio	CMR1	V _{CM} =0V→-13V / V _{CM} =0V→+13V	128	135	-	dB
	CMR2	Ta=-40 to +85°C, V _{CM} =0V→-13V / V _{CM} =0V→+13V	120	130	-	dB
Supply Voltage Rejection Ratio	SVR1	V ⁺ /V ⁻ =±3V to ±18V	115	125	-	dB
	SVR2	Ta=-40 to +85°C, V ⁺ /V ⁻ =±3V to ±18V	110	120	-	dB
Input Bias Current	I _{B1}		-0.2	1.2	2.8	nA
	I _{B2}	Ta=-40 to +85°C	-1.5	1.7	6	nA
Input Bias Current Drift	ΔI _B /ΔT	Ta=-40→+85°C	-	8	60	pA/°C
Input Offset Current	I _{IO1}		-	0.3	2.8	nA
	I _{IO2}	Ta=-40 to +85°C	-	0.3	4.5	nA
Input Offset Current Drift	ΔI _{IO} /ΔT	Ta=-40→+85°C	-	1.5	72	pA/°C
Differential Input Impedance	R _{ID}	*1	-	90	-	MΩ
Common-Mode Input Impedance	R _{IC}	*1	-	800	-	GΩ
Voltage Gain	Av1	R _L =2kΩ, V _o =-10V→0V / 0V→+10V / -10V→+10V	130	142	-	dB
	Av2	Ta=-40 to +85°C, R _L =2kΩ, V _o =-10V→0V / 0V→+10V / -10V→+10V	126	136	-	dB
Channel Separation	CS	DC	-	0.01	-	μV/V
Output Characteristics						
Maximum Output Voltage	V _{OM1}	R _L =10kΩ	±13.5	±14.0	-	V
	V _{OM2}	Ta=-40 to +85°C, R _L =10kΩ	±13.0	±14.0	-	V
	V _{OM3}	R _L =2kΩ	±12.5	±13.0	-	V
	V _{OM4}	Ta=-40 to +85°C, R _L =2kΩ	±12.0	±13.0	-	V
	V _{OM5}	R _L =1kΩ	±12.0	±12.5	-	V
Output Resistance	R _O	Open-Loop	-	60	-	Ω
Supply Characteristics						
Supply Current	I _{CC1}	A _V =+1, R _L =∞	-	2.6	3.2	mA
	I _{CC2}	Ta=-40 to +85°C, A _V =+1, R _L =∞	-	2.7	3.4	mA
	I _{CC3}	V ⁺ /V ⁻ =±3V, A _V =+1, R _L =∞	-	1.3	1.6	mA
	P _{D1}	A _V =+1, R _L =∞	-	78	96	mW
	P _{D1}	V ⁺ /V ⁻ =±3V, A _V =+1, R _L =∞	-	81	102	mW

*1 Theoretical value by design

● AC CHARACTERISTICS

PARAMETER	SYMBOL	TEST CONDITION	MIN.	TYP.	MAX.	UNIT
Frequency Characteristics						
Unity Gain Frequency	f_T	$A_V=+100, R_L=2k\Omega, C_L=10pF$	-	1.1	-	MHz
Slew Rate	+SR	RISE, $A_V=+1, V_{IN}=1V_{pp}, R_L=2k\Omega$	0.1	0.3	-	V/ μ S
	-SR	FALL, $A_V=+1, V_{IN}=1V_{pp}, R_L=2k\Omega$	0.1	0.3	-	V/ μ S
Noise Characteristics						
Equivalent Input Noise Voltage	V_{NI}	fo=1Hz to 100Hz	-	80	-	nVrms
Equivalent Input Noise Current	I_{NI}	fo=1Hz to 100Hz	-	3	-	pArms

■ ELECTRONIC CHARACTERISTICS ($V^+ / V^- = \pm 5V, T_a = +25^\circ C, V_{CM} = 0V$ unless otherwise specified)

PARAMETER	SYMBOL	TEST CONDITION	MIN.	TYP.	MAX.	UNIT
Input Characteristics						
Input Offset Voltage	V_{IO1}		-	30	70	μ V
	V_{IO2}	$T_a = -40^\circ C$ to $+85^\circ C$	-	35	110	μ V
Common Mode Input Voltage Range	V_{ICM1}		± 3	± 3.9	-	V
	V_{ICM2}	$T_a = -40^\circ C$ to $+85^\circ C$	± 3	± 3.5	-	dB
Common Mode Rejection Ratio	CMR1	$V_{CM}=0V \rightarrow -3V / V_{CM}=0V \rightarrow +3V$	115	125	-	dB
	CMR2	$T_a = -40^\circ C$ to $+85^\circ C, V_{CM}=0V \rightarrow -3V / V_{CM}=0V \rightarrow +3V$	105	118	-	dB
Input Bias Current	I_{B1}		-0.2	0.7	2.0	nA
	I_{B2}	$T_a = -40^\circ C$ to $+85^\circ C$	-0.2	1.0	6.0	nA
Input Offset Current	I_{IO1}		-	0.3	2.8	nA
	I_{IO2}	$T_a = -40^\circ C$ to $+85^\circ C$	-	0.3	4.5	nA
Voltage Gain	A_{V1}	$R_L=2k\Omega, V_o = -3V \rightarrow 0V / 0V \rightarrow +3V / -3V \rightarrow +3V$	115	130	-	dB
	A_{V2}	$T_a = -40^\circ C$ to $+85^\circ C, R_L=2k\Omega, V_o = -3V \rightarrow 0V / 0V \rightarrow +3V / -3V \rightarrow +3V$	110	125	-	dB
Channel Separation	CS	DC	-	0.01	-	μ V/V
Output Characteristics						
Maximum Output Voltage	V_{OM1}	$R_L=10k\Omega$	± 3.5	± 4.0	-	V
	V_{OM2}	$T_a = -40^\circ C$ to $+85^\circ C, R_L=10k\Omega$	± 3.5	± 4.0	-	V
	V_{OM3}	$R_L=2k\Omega$	± 3.5	± 4.0	-	V
	V_{OM4}	$T_a = -40^\circ C$ to $+85^\circ C, R_L=2k\Omega$	± 3.5	± 4.0	-	V
Supply Characteristics						
Supply Current	I_{CC1}	$A_V=+1, R_L=\infty$	-	1.6	2.0	mA
	I_{CC2}	$T_a = -40^\circ C$ to $+85^\circ C, A_V=+1, R_L=\infty$	-	1.7	2.1	mA

● EXPLANATION OF MEASUREMENT CONDITION

PARAMETER	Explanation
Input Offset Voltage Drift	$\text{Input Offset Voltage Drift} = \Delta V_{IO} / \Delta T$ $\Delta T : \text{Amount of Temperature change.}$ $\Delta V_{IO} : \text{Amount of Input Offset Voltage.}$
Common Mode Input Voltage range	A range of input voltage at which the operational amplifier can function.
Common Mode Rejection Ratio	$\text{CMR} = 20 \log (\Delta V_{CM} / \Delta V_{IO}) $ $\Delta V_{CM} : \text{Amount of Input Voltage.}$ $\Delta V_{IO} : \text{Amount of Input Offset Voltage.}$
Supply Voltage Rejection Ratio	$\text{SVR} = 20 \log (\Delta V_S / \Delta V_{IO}) $ $\Delta V_S : \text{Amount of supply Voltage.}$ $\Delta V_{IO} : \text{Amount of Input Offset Voltage.}$
Common Mode Input Impedance	$R_{IC} = \Delta V_{CM} / \Delta I_B$ $\Delta V_{CM} : \text{Amount of Input Voltage.}$ $\Delta I_B : \text{Amount of Input bias current.}$
Voltage Gain	$A_V = 20 \log (\Delta V_O / \Delta V_{IO}) $ $\Delta V_O : \text{Amount of output Voltage.}$ $\Delta V_{IO} : \text{Amount of Input offset Voltage.}$

■ TYPICAL CHARACTERISTICS

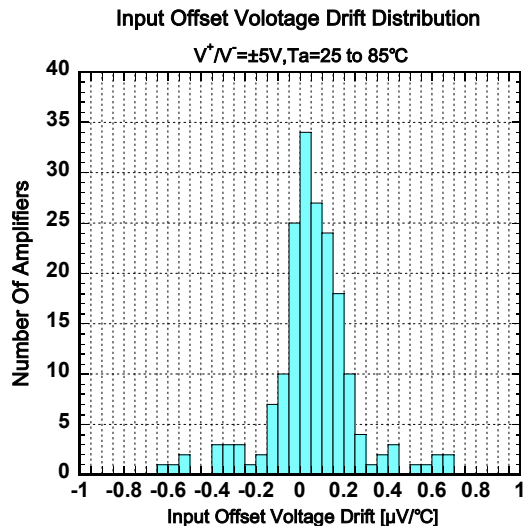
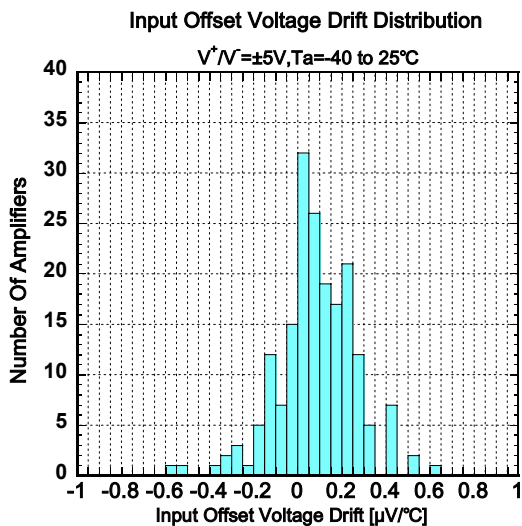
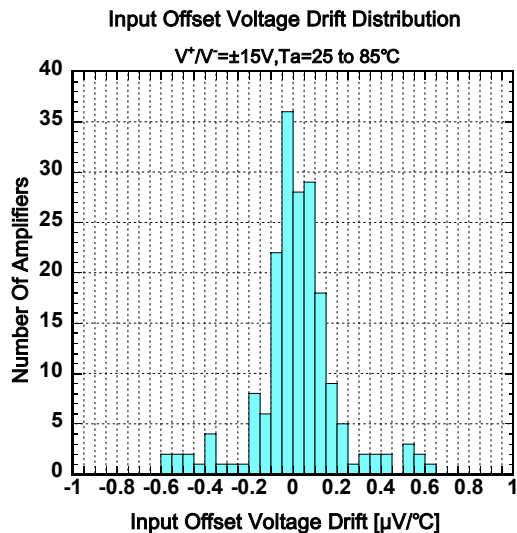
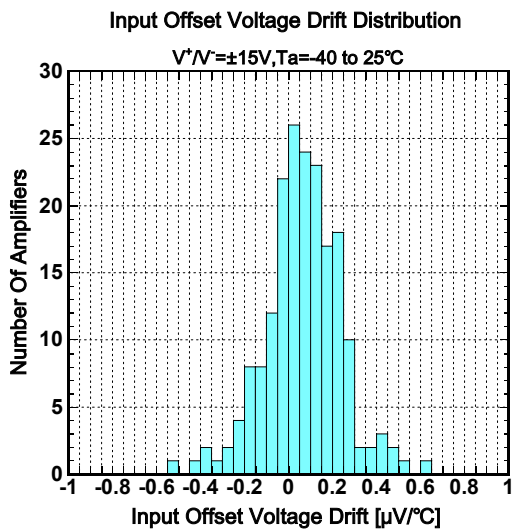
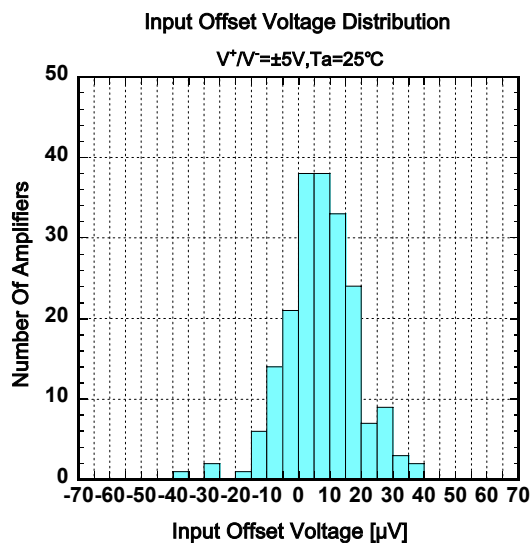
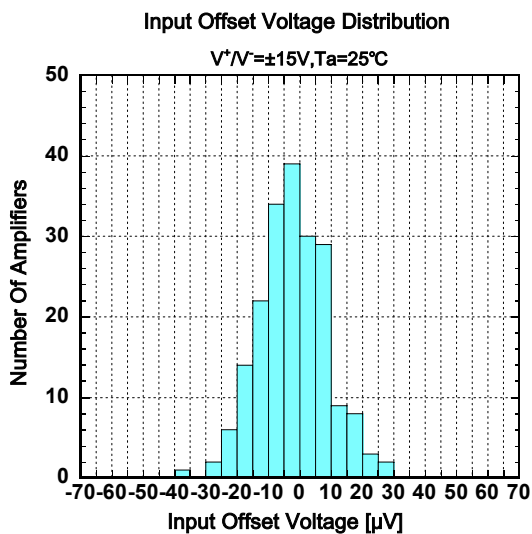

■ TYPICAL CHARACTERISTICS

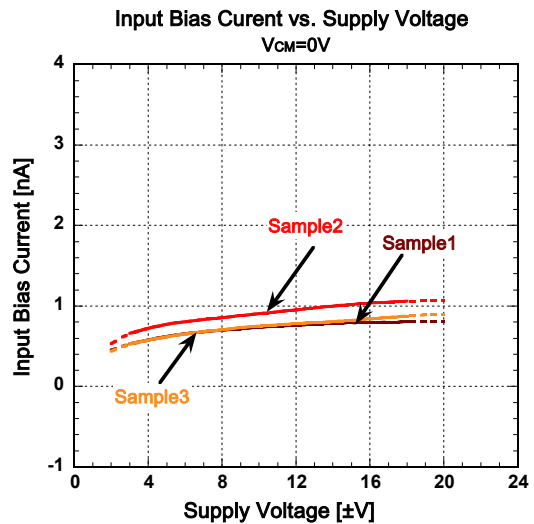
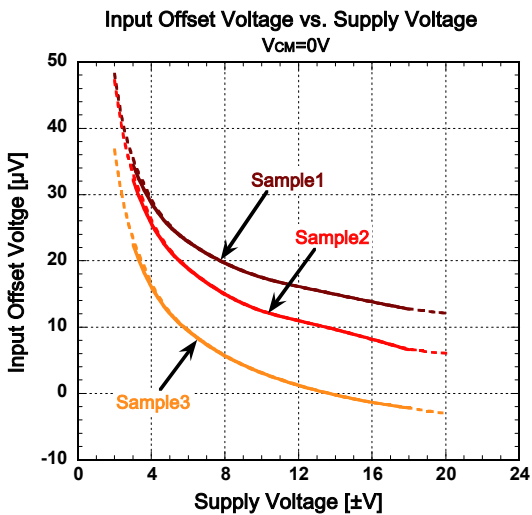
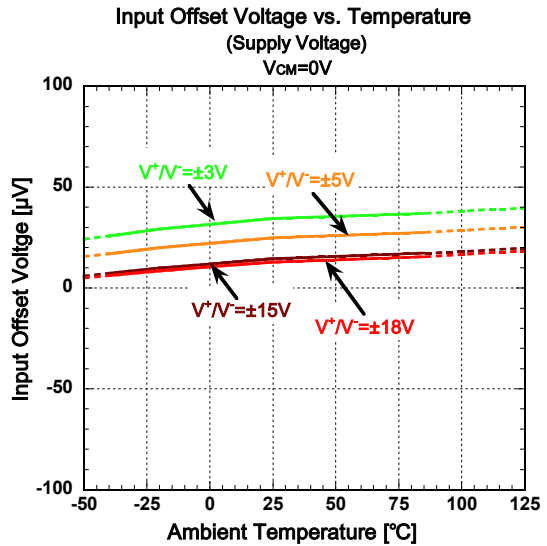
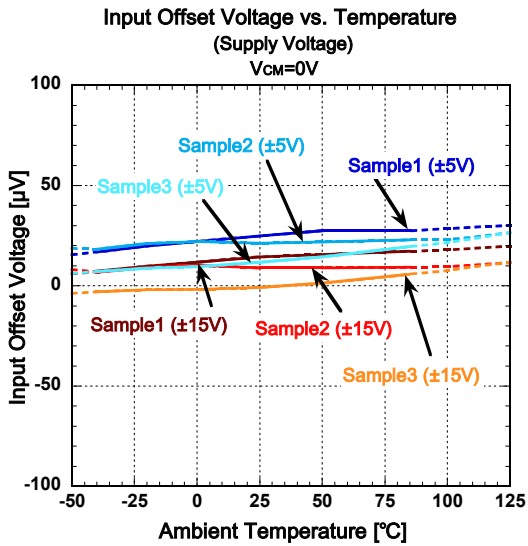
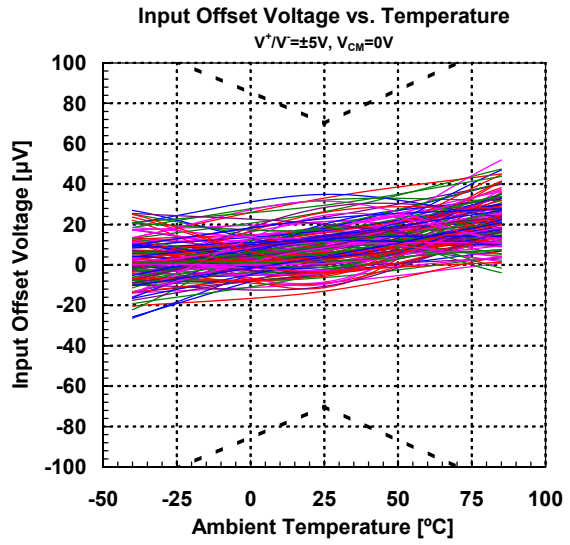
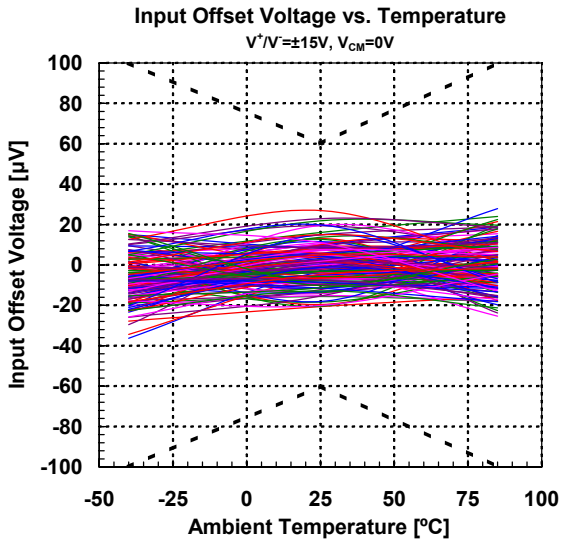

■ TYPICAL CHARACTERISTICS

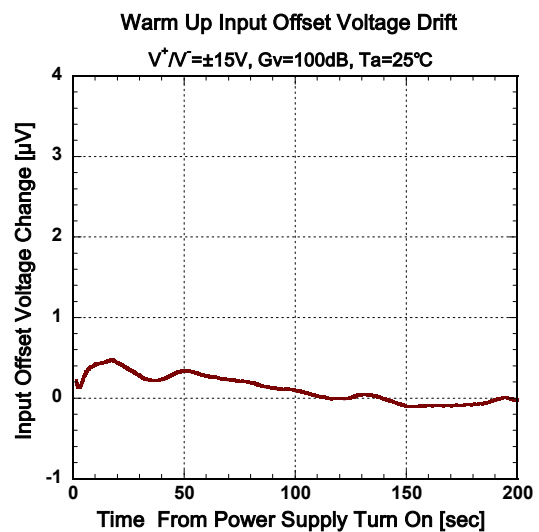
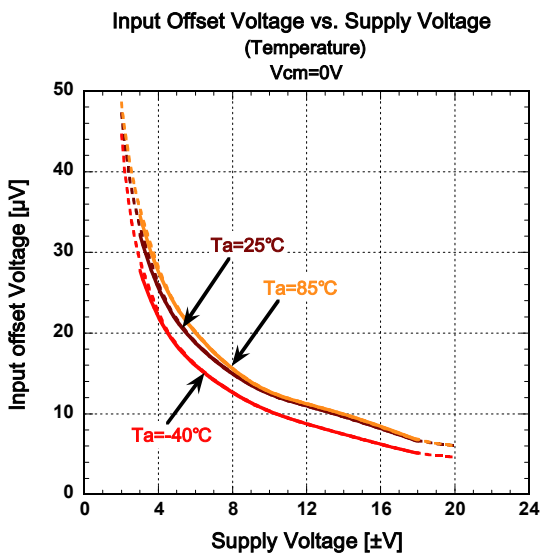
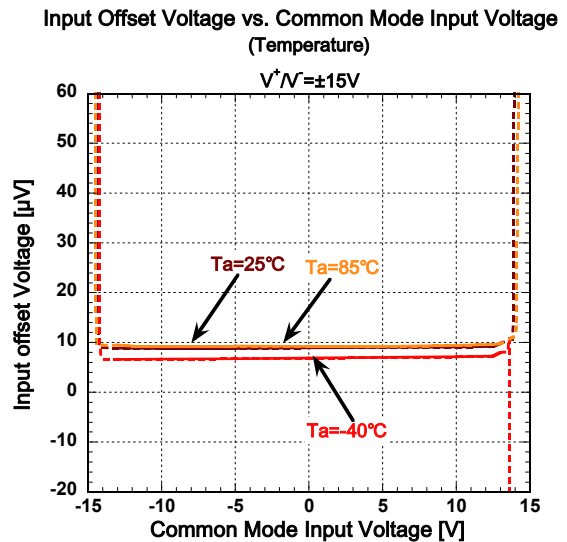
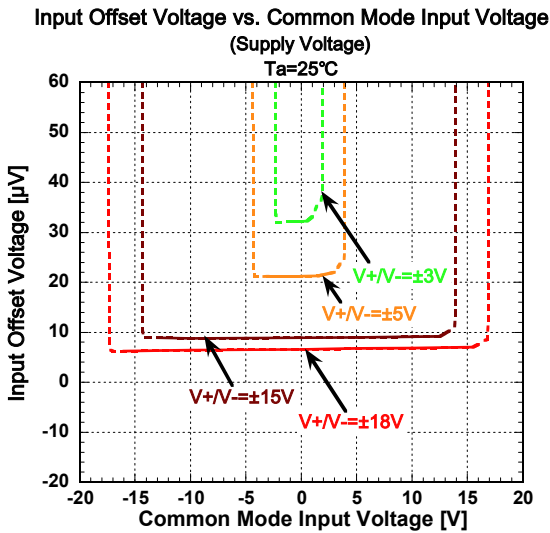
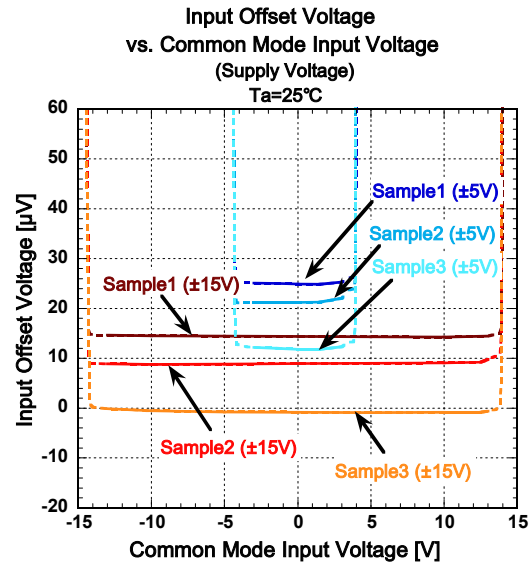
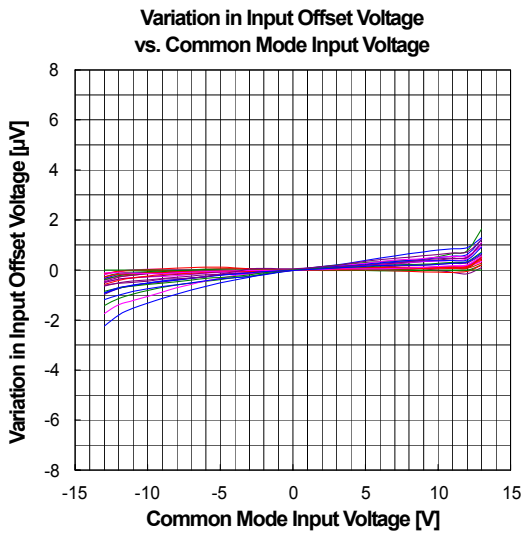

■ TYPICAL CHARACTERISTICS

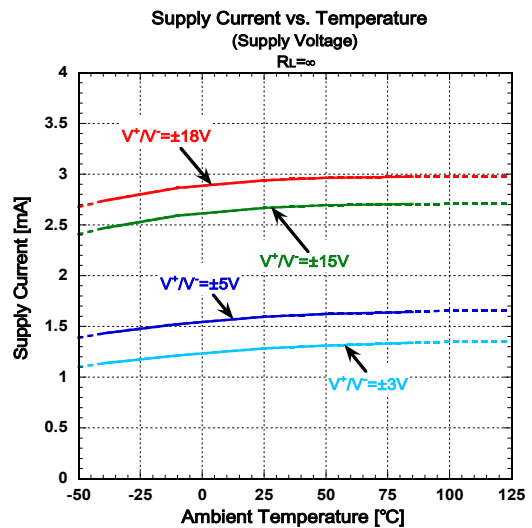
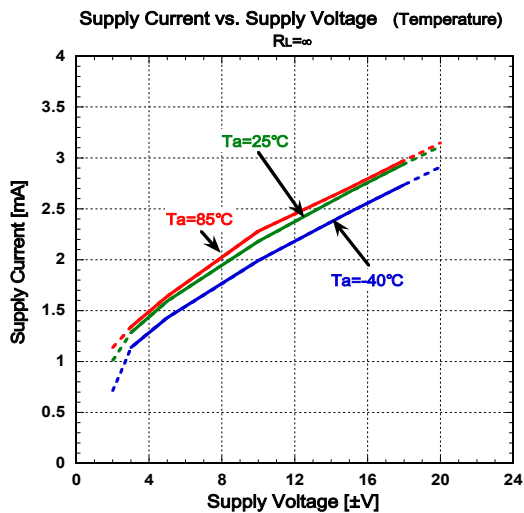
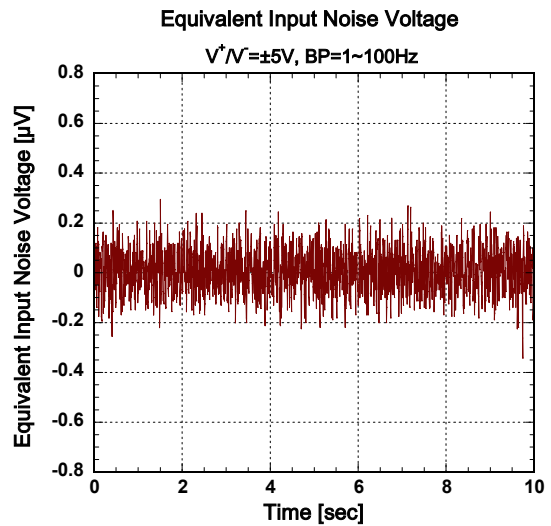
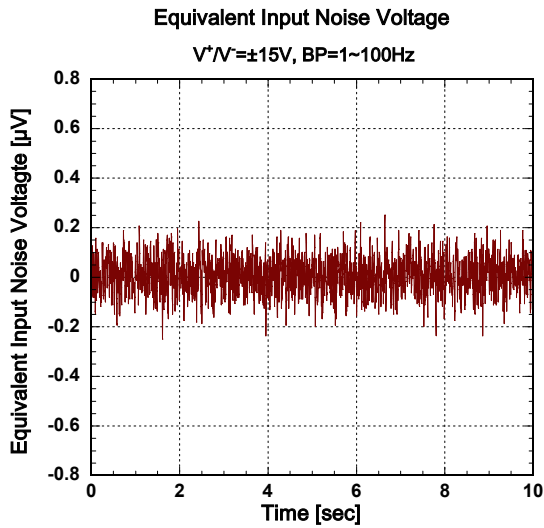
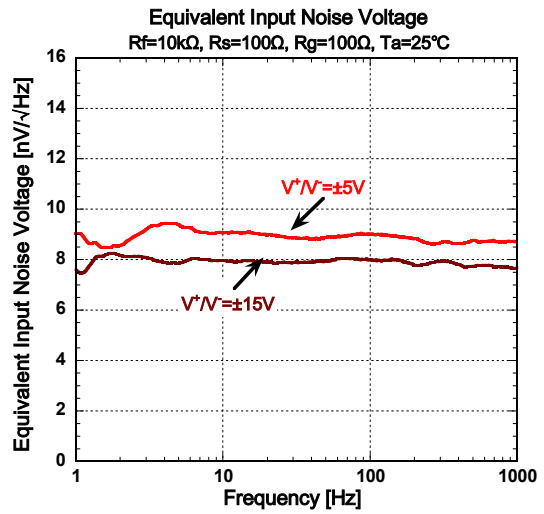
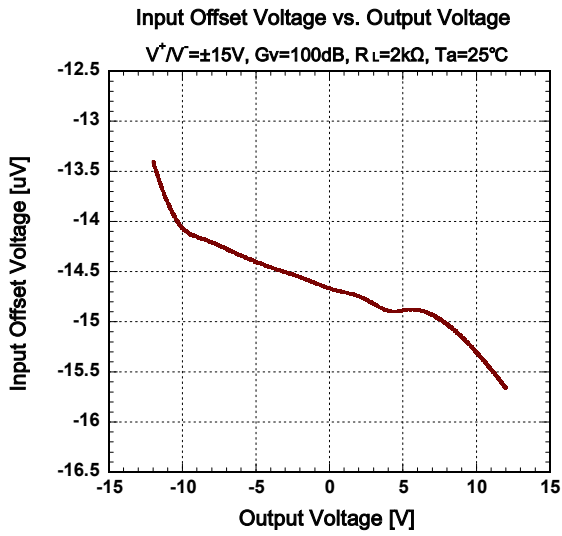

■ TYPICAL CHARACTERISTICS

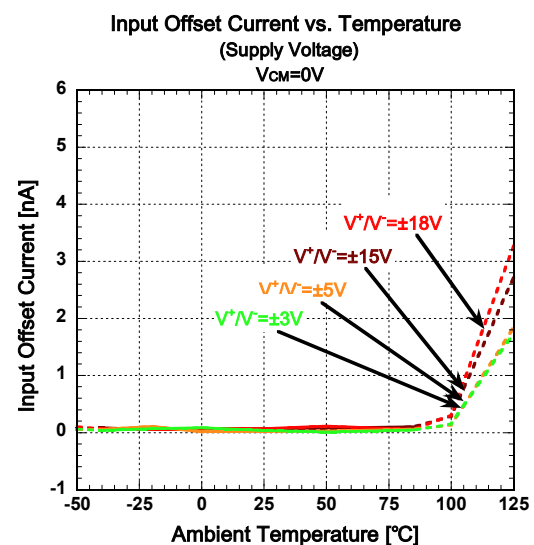
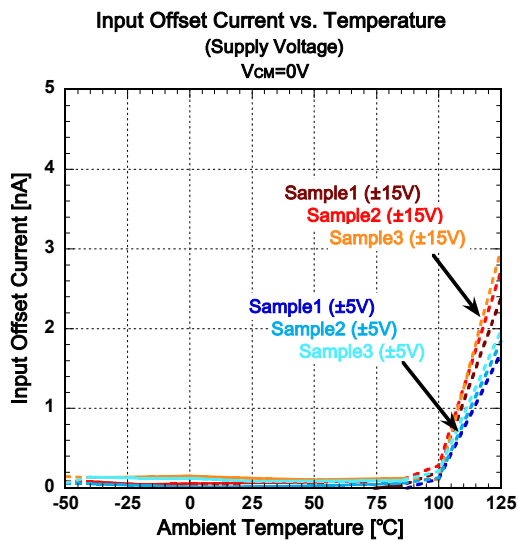
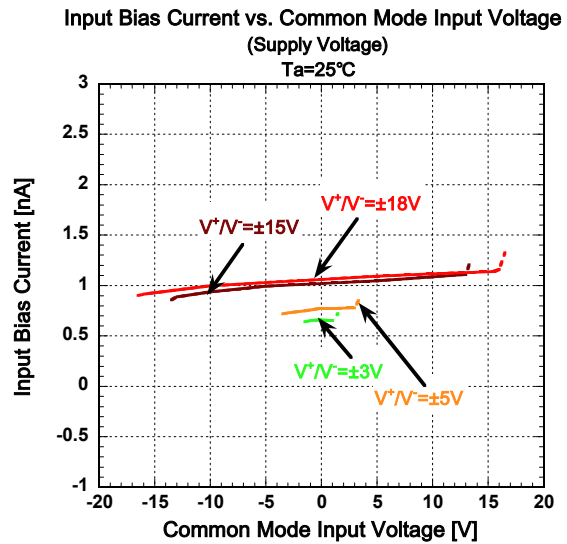
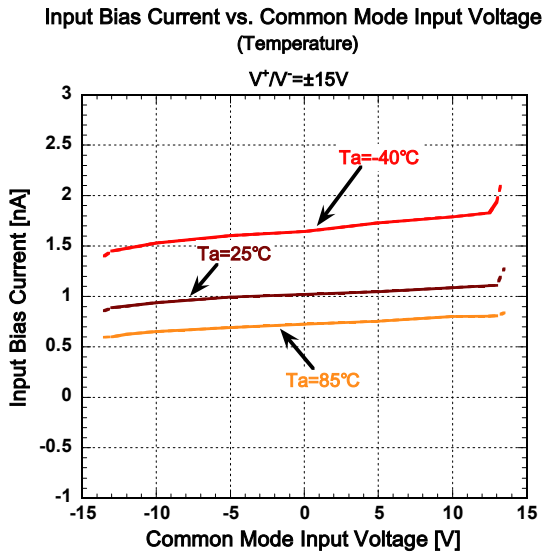
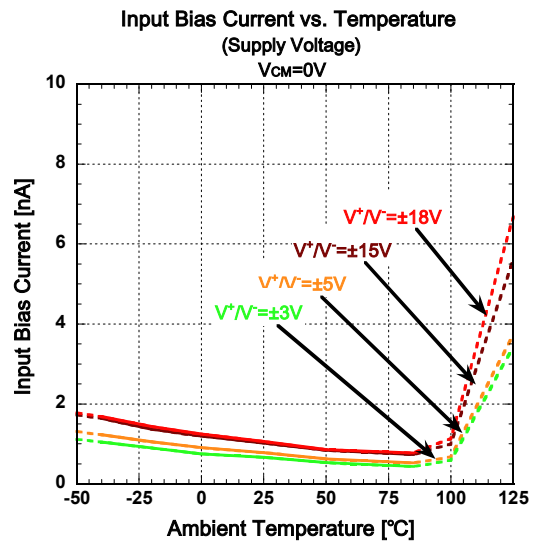
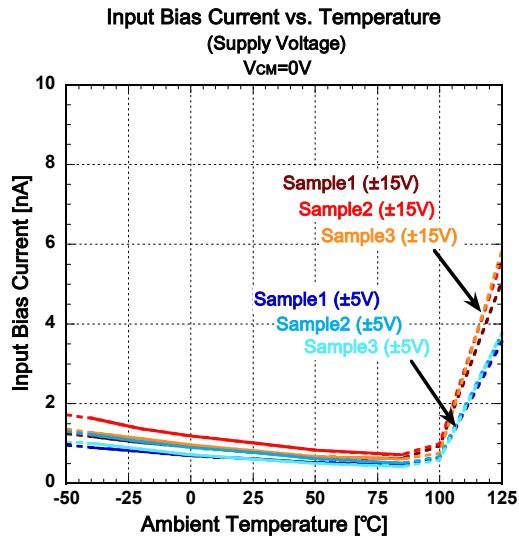

■ TYPICAL CHARACTERISTICS

Input Offset Current vs. Common Mode Input Voltage
(Temperature)

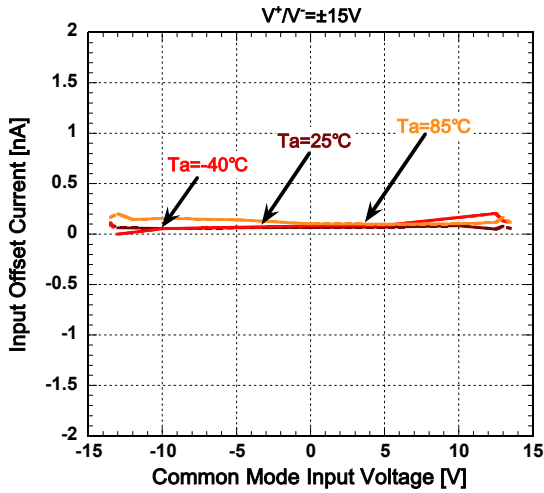

Input Offset Current vs. Common Mode Input Voltage
(Supply Voltage)

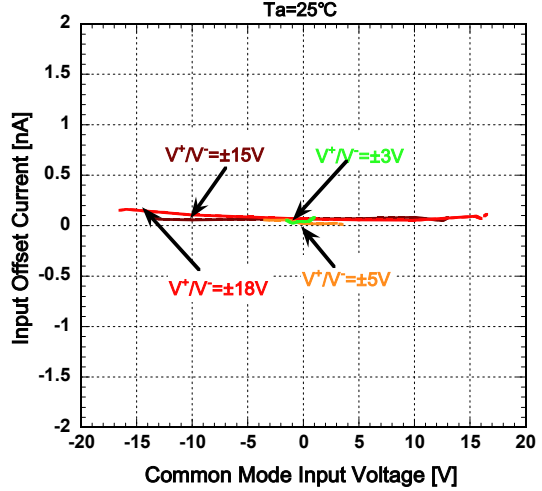

Common Mode Rejection Ratio vs. Temperature
(Supply Voltage)

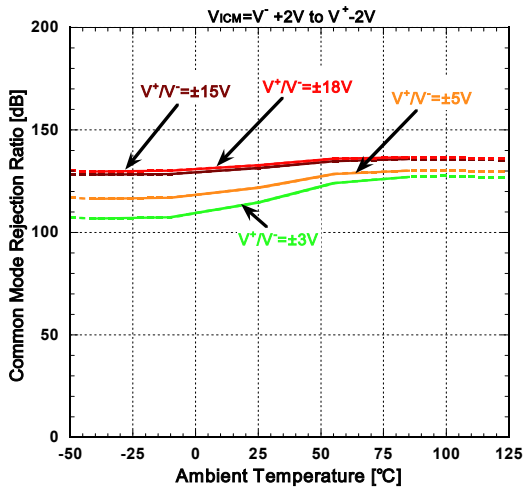

Common Mode Rejection Ratio vs. Frequency

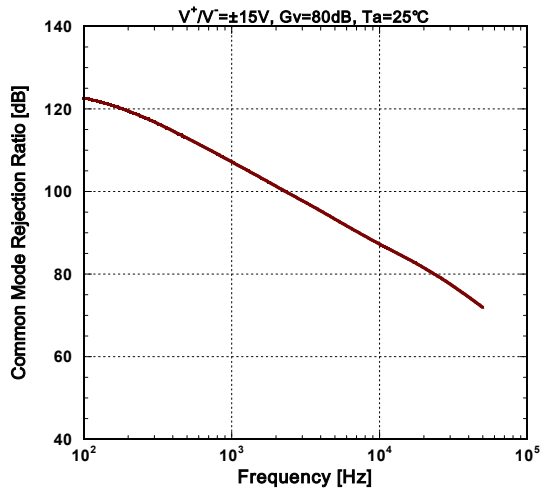

Supply Voltage Rejection Ratio vs. Frequency

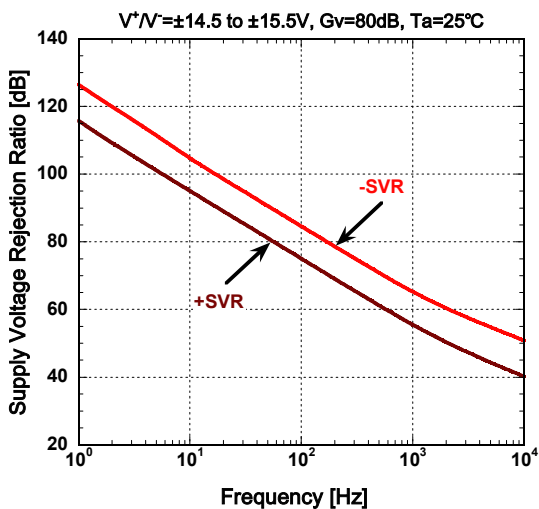

Supply Voltage Rejection Ratio vs. Temperature

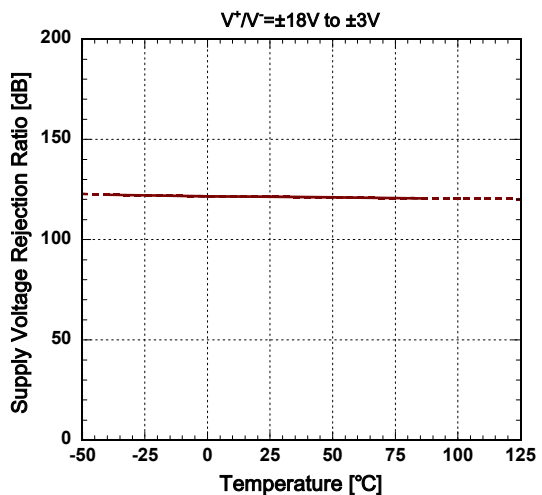

■ TYPICAL CHARACTERISTICS

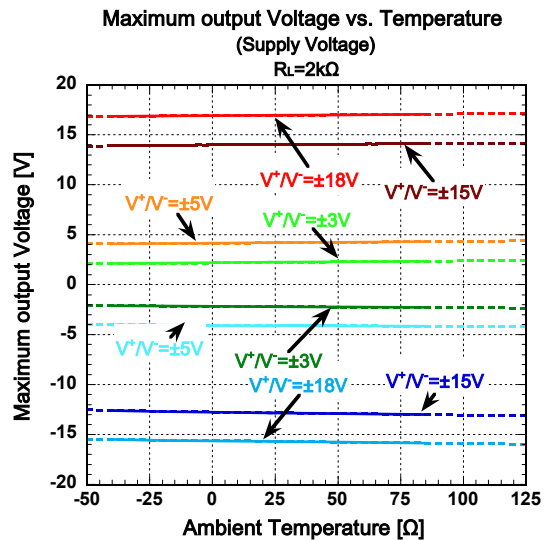
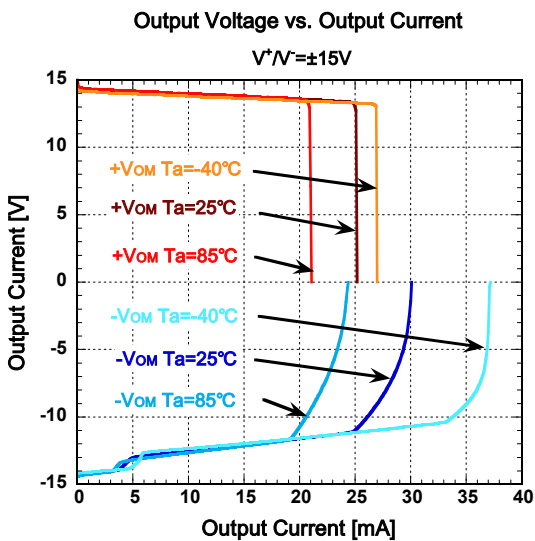
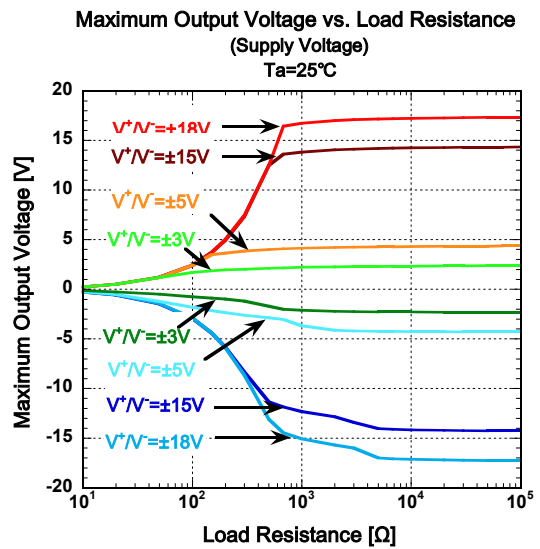
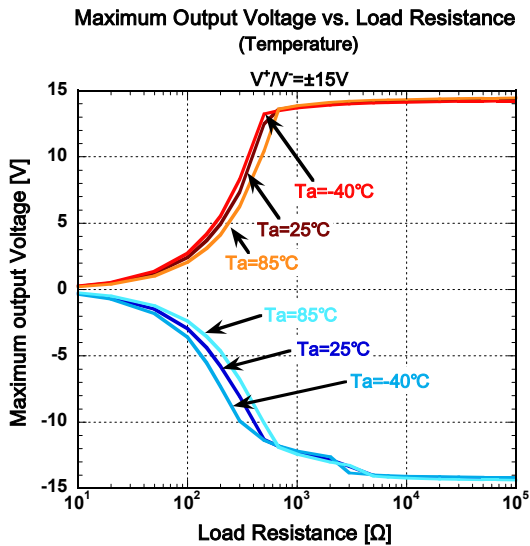
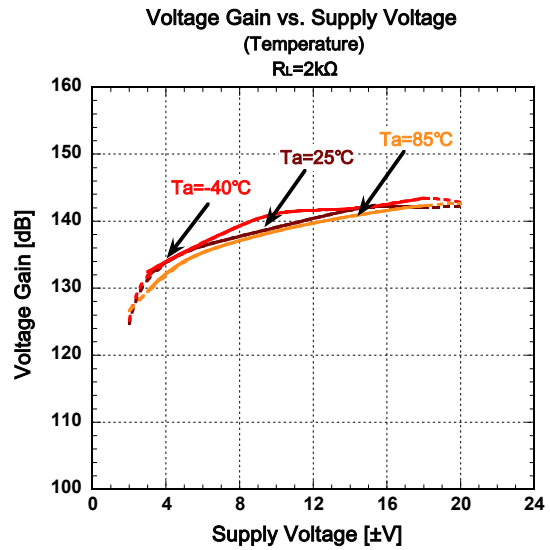
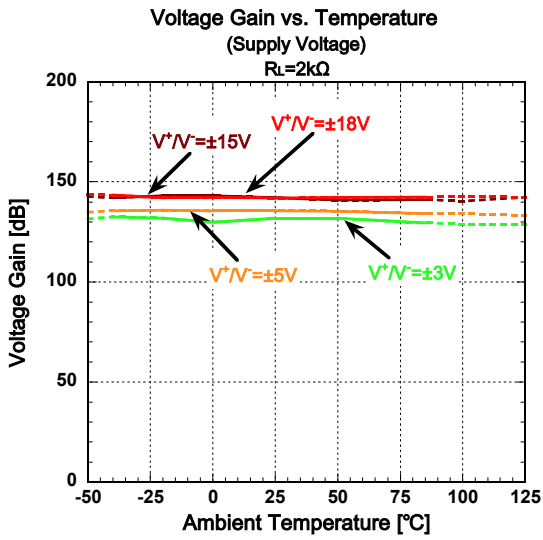

■ TYPICAL CHARACTERISTICS

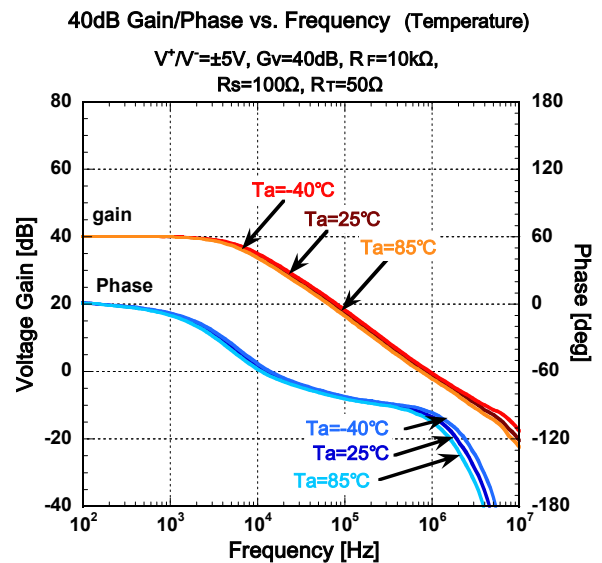
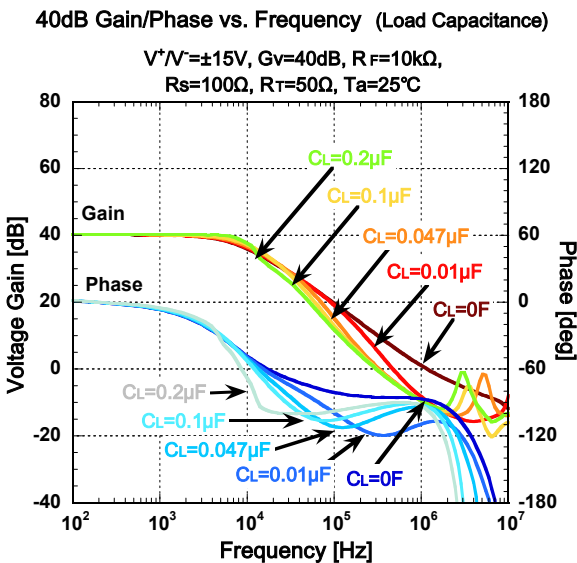
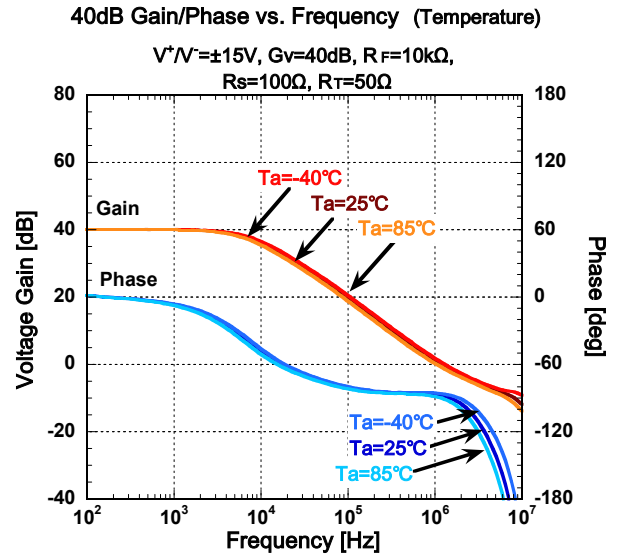
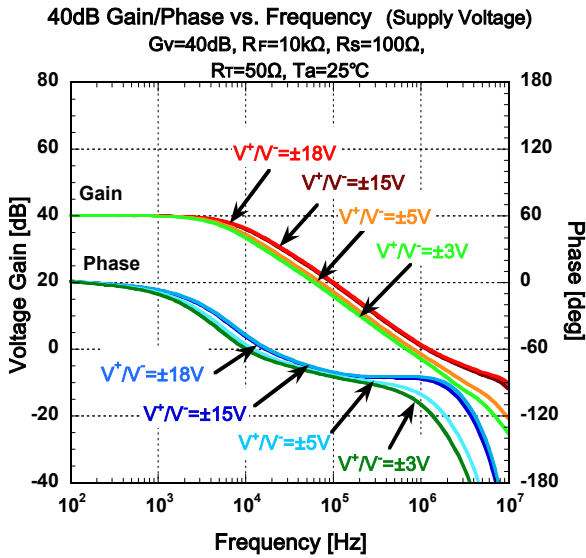
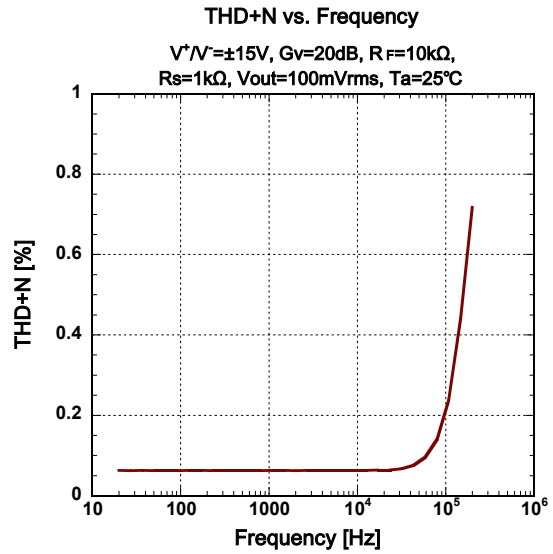
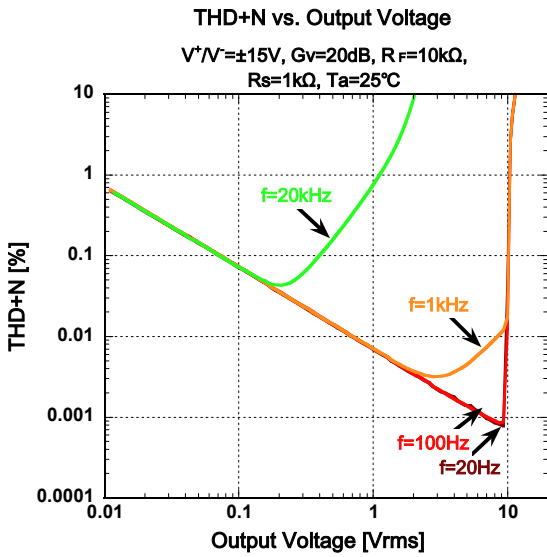

■ TYPICAL CHARACTERISTICS

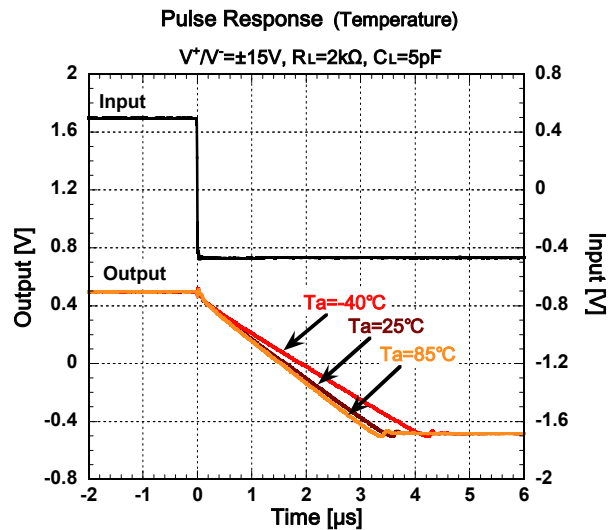
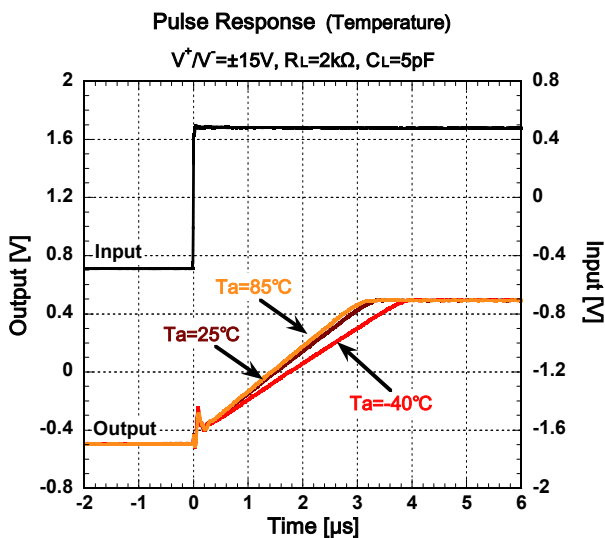
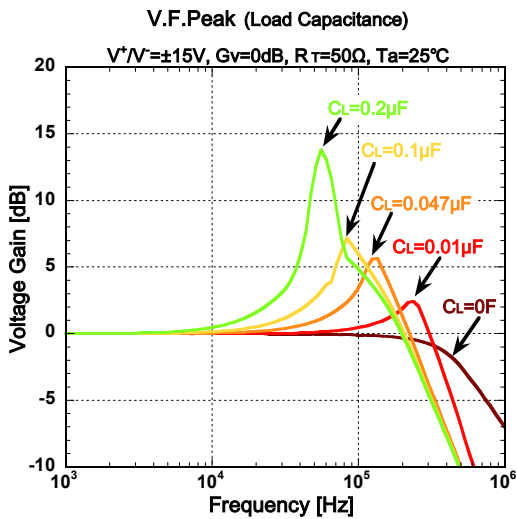
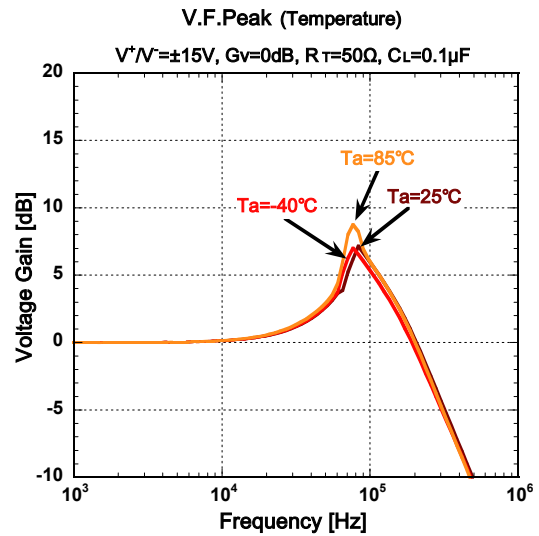
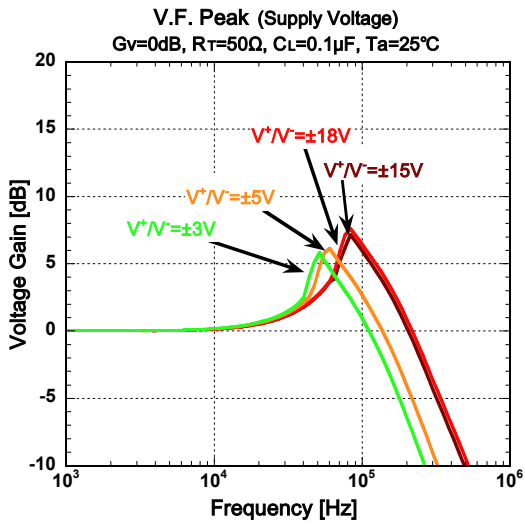

■ TYPICAL CHARACTERISTICS

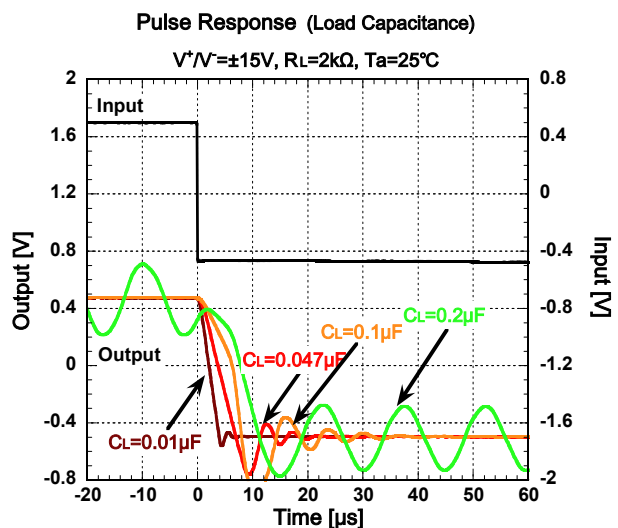
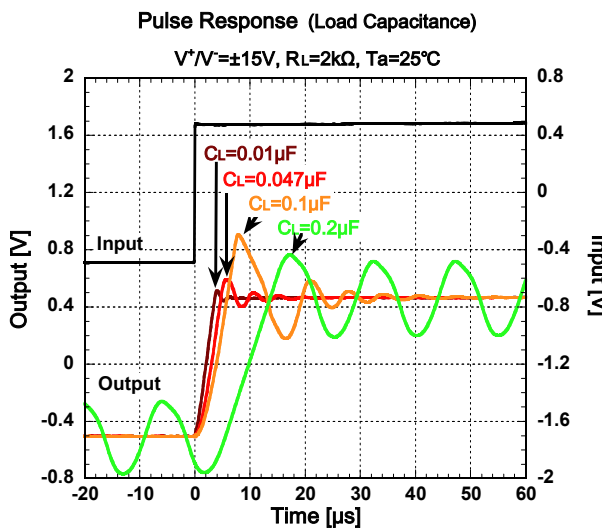
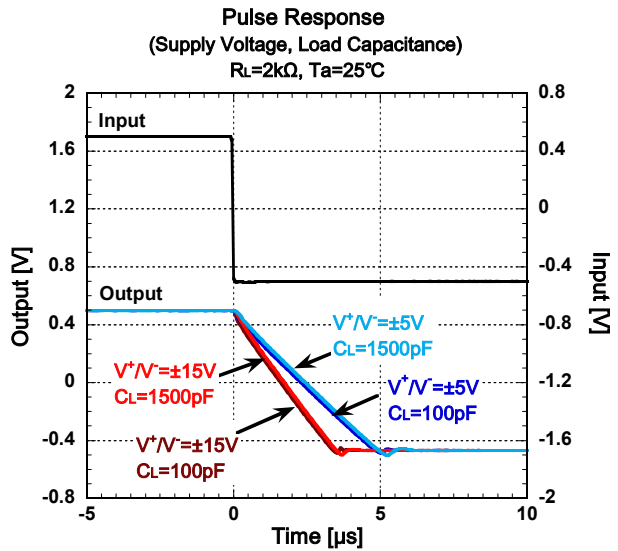
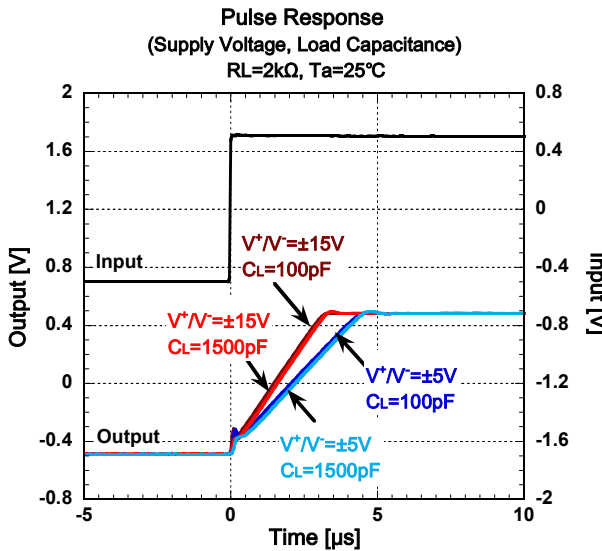
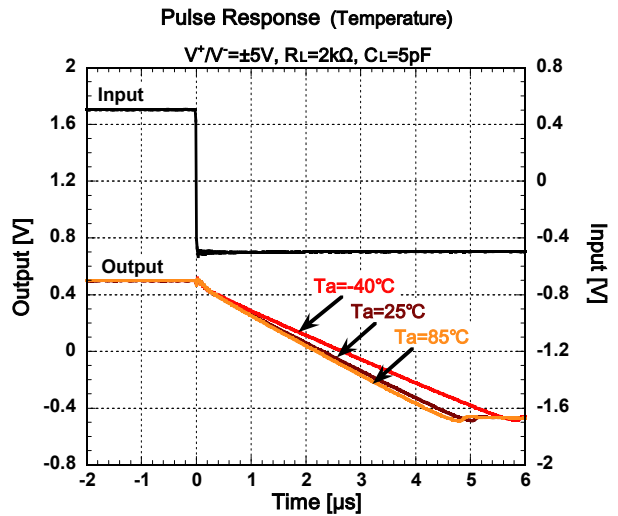
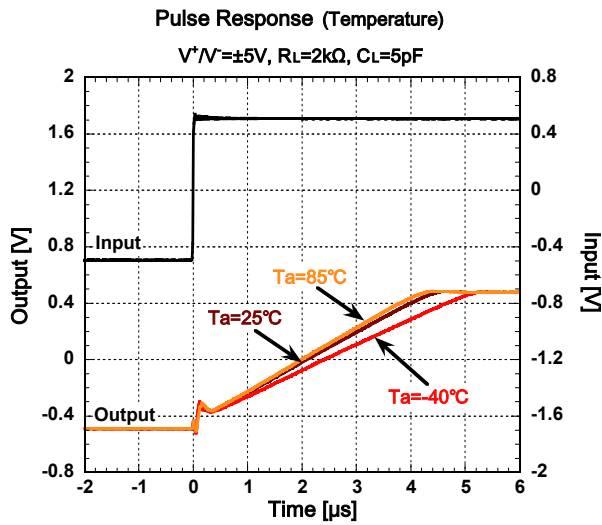

■ TYPICAL CHARACTERISTICS

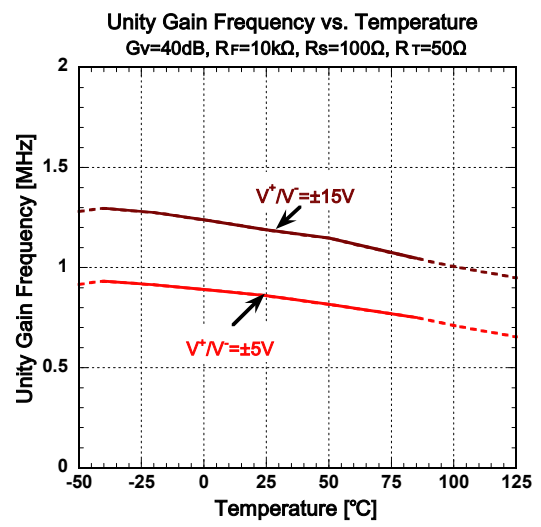
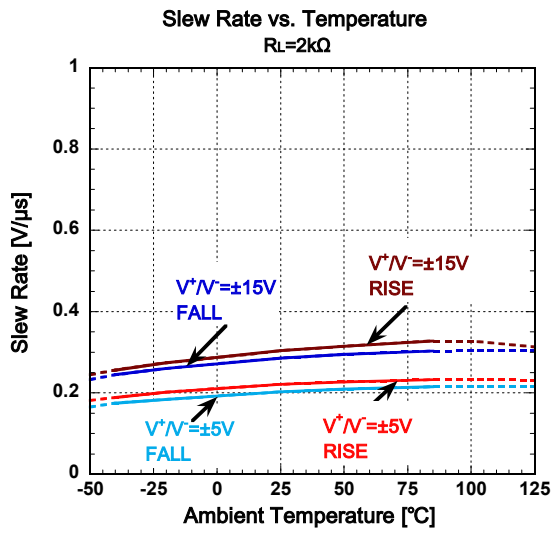

NJM2739

■ Application Information

● Power Supply Bypassing

The NJM2739 is a high precision operational amplifier featuring low offset voltage, high voltage gain, high CMR, high SVR and so on. To maximize such a high performance with stable operation, the NJM2739 should be operated by clean and low impedance supply voltage. So, the bypass capacitor should be connected to the NJM2739's both power supply terminals (V+ and V-) as shown in Fig.1. The bypass capacitors should be placed as close as possible to IC package

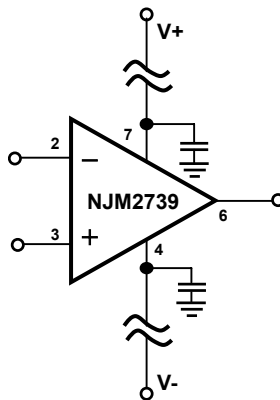

Fig.1 Power Supply Bypassing Circuit

● Thermoelectric Effect

The NJM2739 is a high precision operational amplifier featuring low offset voltage and low offset voltage thermal drift. To achieve such a high performance, take care about thermoelectric effect possibly occurs on each input terminal of the NJM2739. Generally, if there are thermal mismatches at the junction of different types of metals, the thermoelectric voltage (Seebeck effect) occurs at the junction. The thermoelectric voltages possibly occur at the junction of PCB metal patterns and NJM2739's each input terminal metal. If there is thermal mismatch in-between NJM2739's each input terminal metal, the thermoelectric voltages generated on each input terminal possibly have different voltage each. This voltage difference causes offset voltage and offset voltage thermal drift of the NJM2739. To minimize this voltage difference, the thermal mismatch in-between NJM2739's each input terminal and PCB metal should be minimized.

● Differential Amplifier

Differential amplifier (see below Fig.2) is used in high accuracy circuit to improve common mode rejection ratio (CMR).

A matching between the ratio $R_1/R_2 = R_3/R_4$ and $R_1=R_3$ makes the high CMR.

For example, acceptable error range to obtain CMR of 130dB or more is about 0.1ppm.

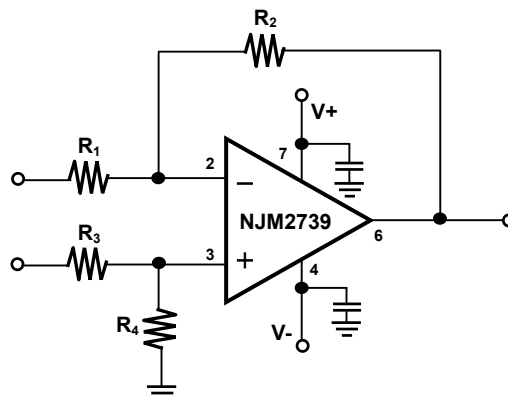

Fig.2 Differential Amplifier

[CAUTION]
The specifications on this data book are only given for information, without any guarantee as regards either mistakes or omissions. The application circuits in this data book are described only to show representative usages of the product and not intended for the guarantee or permission of any right including the industrial rights.