

LOW DROPOUT VOLTAGE REGULATOR WITH ON/OFF CONTROL

■ GENERAL DESCRIPTION

The NJM2386A is a general purpose low dropout voltage regulators with ON/OFF control.

The output current is up to 1.0A and dropout voltage is up 0.2V typical at 500mA load.

It features high maximum input voltage of 30V for a wide application range including TV, home appliance and power modules.

Compared with the NJM2386, Off control quiescent current is significantly reduces for current sensitive applications.

■ PACKAGE OUTLINE

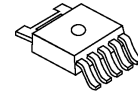

NJM2386ADL3

■ FEATURES

- High Maximum Input Voltage Up to 30V
- Low Dropout Voltage 0.2V typ. at $I_o=0.5A$
- Output Current $I_o(max.)=1.0A$
- ON/OFF Control
- OFF Control Quiescent Current 1 μ A max.
- Internal Short Circuit Current Limit
- Internal Overvoltage Protection
- Internal Thermal Overload Protection
- Bipolar Technology
- Package Outline TO-252-5

■ PIN CONFIGURATION

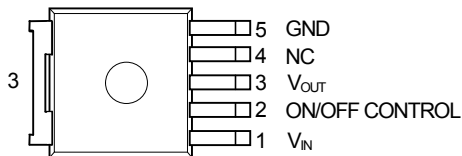

NJM2386ADL3

■ BLOCK DIAGRAM

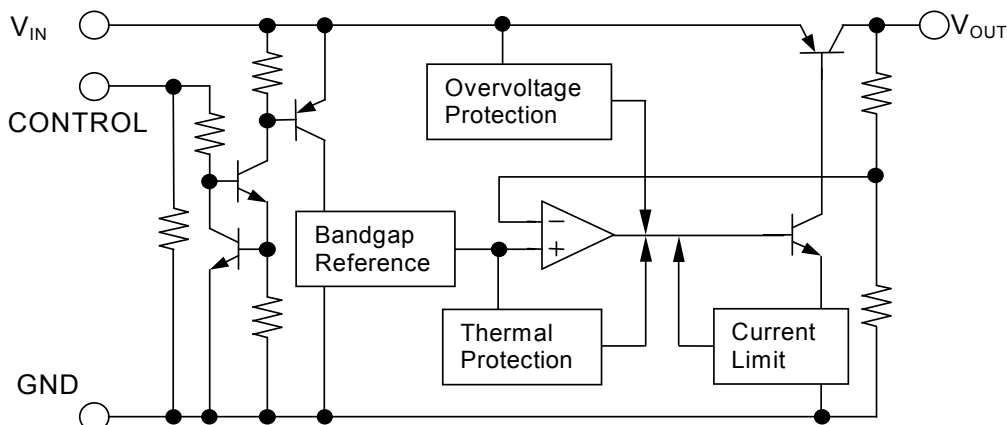

NJM2386A

■ OUTPUT VOLTAGE RANK LIST

Device Name	V _{OUT}	Device Name	V _{OUT}
NJM2386ADL3-33	3.3V	NJM2386ADL3-10	10.0V
NJM2386ADL3-05	5.0V	NJM2386ADL3-12	12.0V
NJM2386ADL3-06	6.0V		
NJM2386ADL3-08	8.0V		
NJM2386ADL3-09	9.0V		

■ ABSOLUTE MAXIMUM RATINGS

(Ta=25°C)

PARAMETER	SYMBOL	RATINGS	UNIT
Input Voltage	V _{IN}	+35	V
Control Voltage	V _{CONT}	+35(*1)	V
Power Dissipation	P _D	1190(*2)	mW
		3125(*3)	
Operating Junction Temperature Range	T _j	-40 ~ +150	°C
Operating Temperature Range	T _{opr}	-40 ~ +85	°C
Storage Temperature Range	T _{stg}	-50 ~ +150	°C

(*1): When input voltage is less than +35V, the absolute maximum control voltage is equal to the input voltage.

(*2): Mounted on glass epoxy board. (76.2 × 114.3 × 1.6mm:based on EIA/JDEC standard size, 2Layers, Cu area 100mm²)

(*3): Mounted on glass epoxy board. (76.2 × 114.3 × 1.6mm:based on EIA/JDEC standard, 4Layers)

(For 4Layers: Applying 74.2 × 74.2mm inner Cu area and a thermal via hole to a board based on JEDEC standard JESD51-5)

■ ELECTRICAL CHARACTERISTICS (V_{IN}=V_O+1V, I_o=0.5A, C_{IN}=0.33μF, C_o=22μF, T_j=25°C)

Measurement is conducted by pulse testing.

PARAMETER	SYMBOL	CONDITIONS	MIN.	TYP.	MAX.	UNIT
Input Voltage	V _{IN}		-	-	30	V
Output Voltage	V _o		-2%	-	+2%	V
Line Regulation	ΔV _o /ΔV _{IN}	V _{IN} =V _O +1V ~ V _O +17V	-	0.04	0.16	%/V
Load Regulation	ΔV _o /ΔI _o	V _{IN} =V _O +2V, I _o =0A ~ 1.0A	-	0.2	1.4	%/A
Average Temperature Coefficient of Output Voltage	ΔV _o /ΔT	T _j =0 ~ +125°C	-	± 0.02	-	%/°C
Quiescent Current	I _Q	I _o =0A, V _{CONT} =2.7V Except I _{CONT}	-	-	5	mA
OFF Control Quiescent Current	I _{Q(OFF)}	V _{CONT} =0V	-	-	1	μA
Dropout Voltage	ΔV _{LO}	I _o =0.5A	-	0.2	0.5	V
Ripple Rejection	NJM2386ADL3-33	RR V _{IN} =V _O +2V, e _{in} =0.5Vrms, f=120Hz	54	67	-	dB
	NJM2386ADL3-05		54	67	-	
	NJM2386ADL3-06		54	67	-	
	NJM2386ADL3-08		52	65	-	
	NJM2386ADL3-09		52	65	-	
	NJM2386ADL3-10		50	63	-	
	NJM2386ADL3-12		50	63	-	
ON Control Voltage	V _{CONT(ON)}		2.0(*4)			
OFF Control Voltage	V _{CONT(OFF)}		-	-	0.4	V
ON Control Current	I _{CONT(ON)}	V _C =2.7V	10	30	50	μA
OFF Control Current	I _{CONT(OFF)}	V _C =0.4V	1	3	5	μA

(*4): When ON/OFF CONTROL pin is open, Output Voltage is OFF.

■ THERMAL CHARACTERISTICS

PARAMETER	SYMBOL	VALUE	UNIT
Junction-to-Ambient thermal resistance	θ_{ja}	105 (*5) 40 (*6)	$^{\circ}\text{C}/\text{W}$
Junction-to-Top of package characterization parameter	ψ_{jt}	17 (*5) 12 (*6)	$^{\circ}\text{C}/\text{W}$

(*5): Mounted on glass epoxy board. (76.2 × 114.3 × 1.6mm:based on EIA/JDEC standard size, 2Layers, Cu area 100mm²)

(*6): Mounted on glass epoxy board. (76.2 × 114.3 × 1.6mm:based on EIA/JDEC standard, 4Layers)

(For 4Layers: Applying 74.2 × 74.2mm inner Cu area and a thermal via hole to a board based on JEDEC standard JESD51-5)

■ POWER DISSIPATION vs. AMBIENT TEMPERATURE

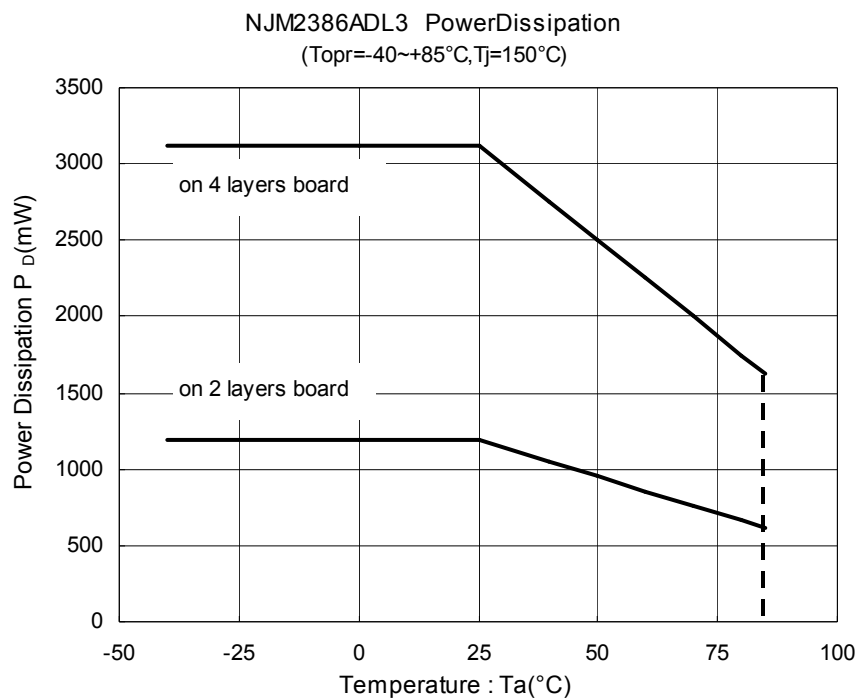

NJM2386A

TEST CIRCUIT

● Standard Test Circuit

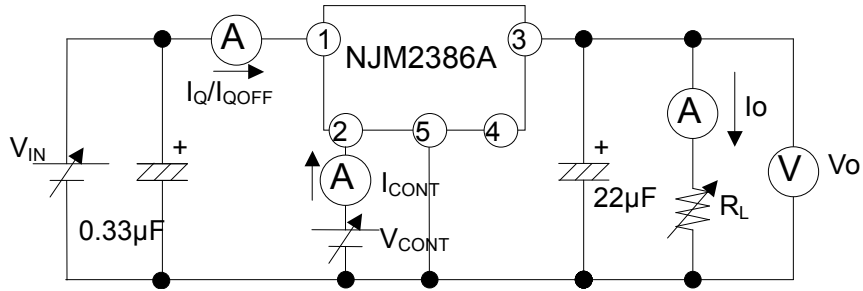

● Ripple Rejection Test Circuit

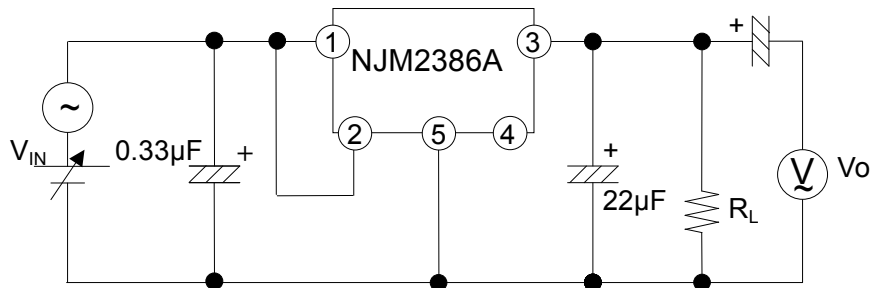

■ TYPICAL APPLICATION

① In the case where ON/OFF Control is not required:

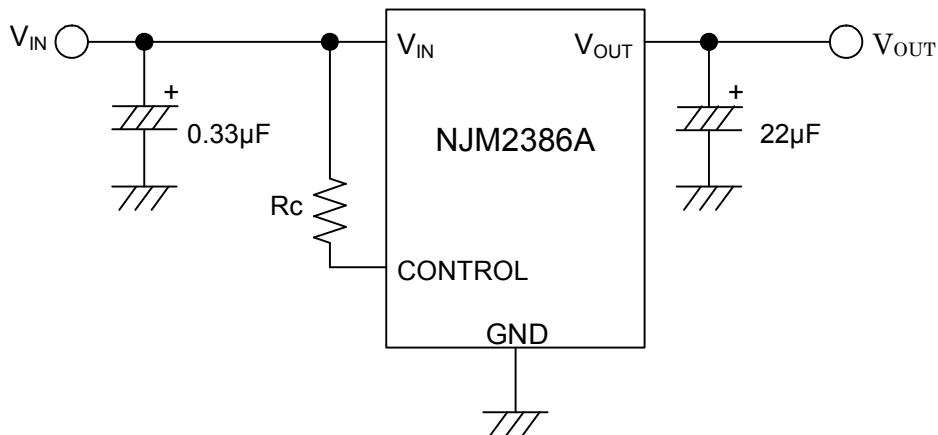

Connect control pin to V_{IN} pin.

② In use of ON/OFF CONTROL:

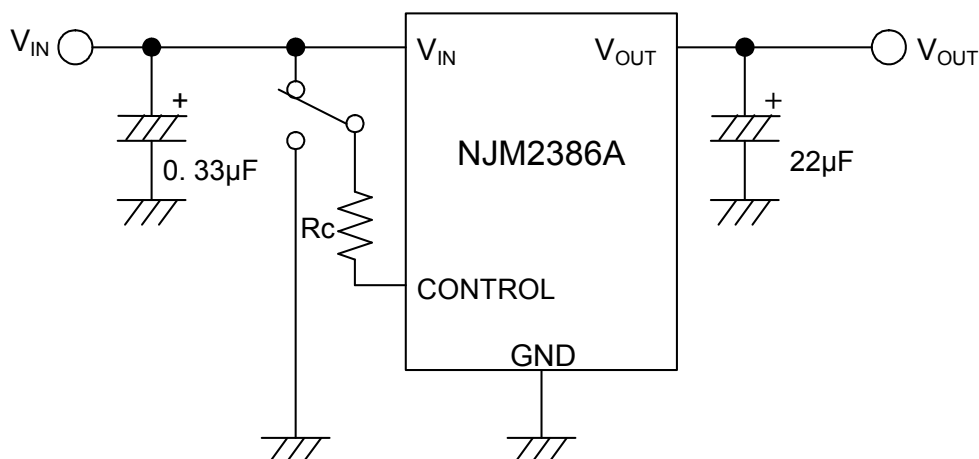

State of control pin:

- “H” → output is enabled.
- “L” or “open” → output is disabled.

*In the case of using a resistance "Rc" between V_{IN} and control.

If this resistor is inserted, it can reduce the control current when the control voltage is high.

The applied voltage to control pin should set to consider voltage drop through the resistor "Rc" and the minimum control voltage for ON-state.

The $V_{CONT(ON)}$ and I_{CONT} have temperature dependence as shown in the "Control Current vs. Temperature" and "Control Voltage vs. Temperature" characteristics. Therefore, the resistance "Rc" should be selected to consider the temperature characteristics.

*Input Capacitor C_{IN}

Input Capacitor C_{IN} is required to prevent oscillation and reduce power supply ripple for applications when high power supply impedance or a long power supply line.

Therefore, use the recommended C_{IN} value (refer to conditions of ELECTRIC CHARACTERISTIC) or larger and should connect between GND and V_{IN} as shortest path as possible to avoid the problem.

*Output Capacitor C_O

Output capacitor (C_O) will be required for a phase compensation of the internal error amplifier.

The capacitance and the equivalent series resistance (ESR) influence to stable operation of the regulator.

Use of a smaller C_O may cause excess output noise or oscillation of the regulator due to lack of the phase compensation.

On the other hand, Use of a larger C_O reduces output noise and ripple output, and also improves output transient response when rapid load change.

Therefore, use the recommended C_O value (refer to conditions of ELECTRIC CHARACTERISTIC) or larger and should connect between GND and V_{OUT} as shortest path as possible for stable operation

In addition, Please choose an appropriate capacitor in considering varied characteristics of capacitor (a frequency characteristic, a temperature characteristic, and so on) when selecting C_O .

TYPICAL CHARACTERISTICS

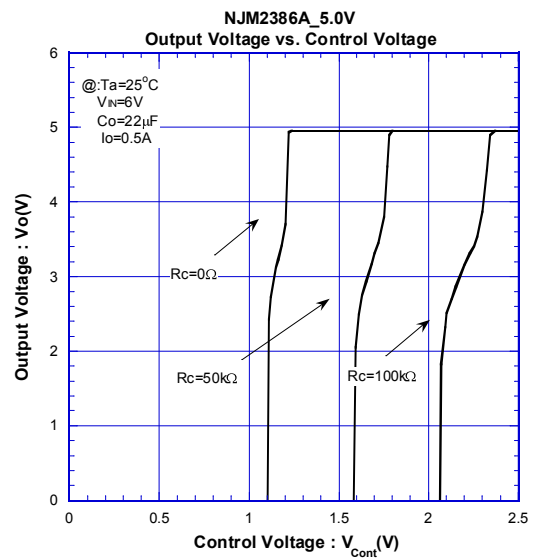
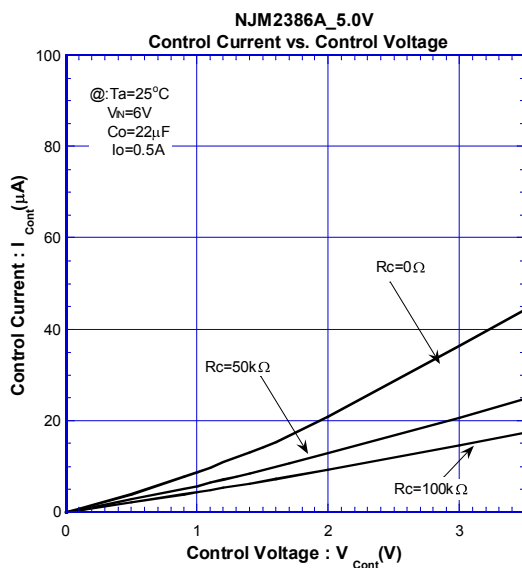
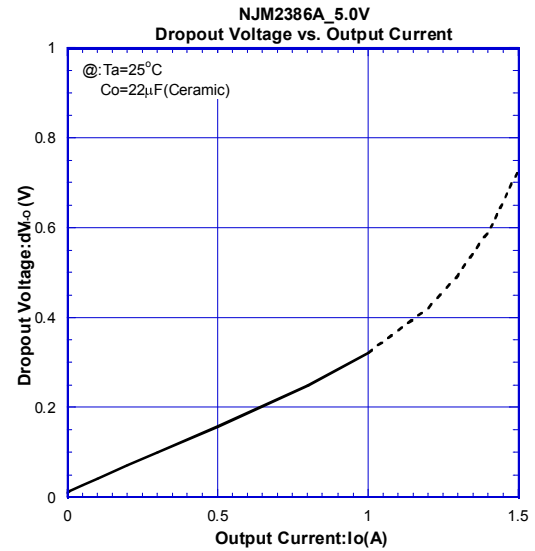
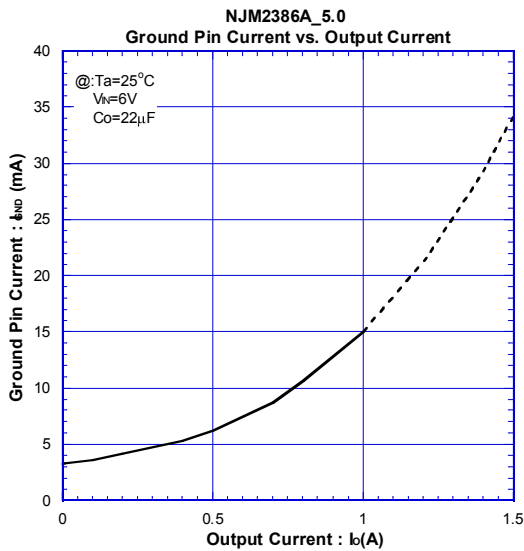
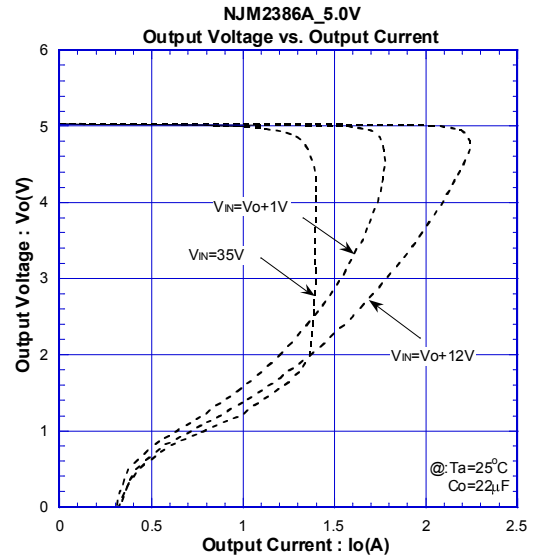
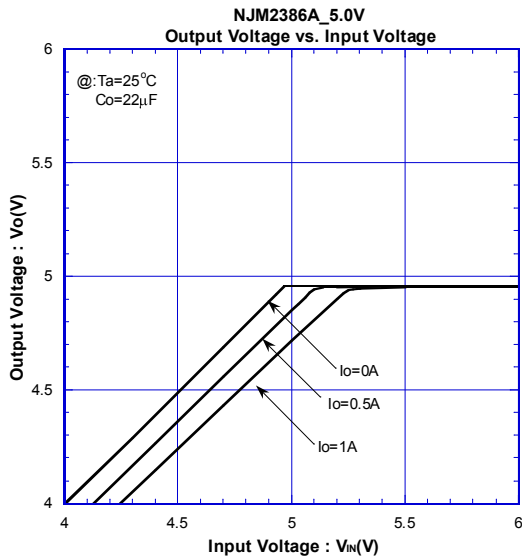

NJM2386A

TYPICAL CHARACTERISTICS

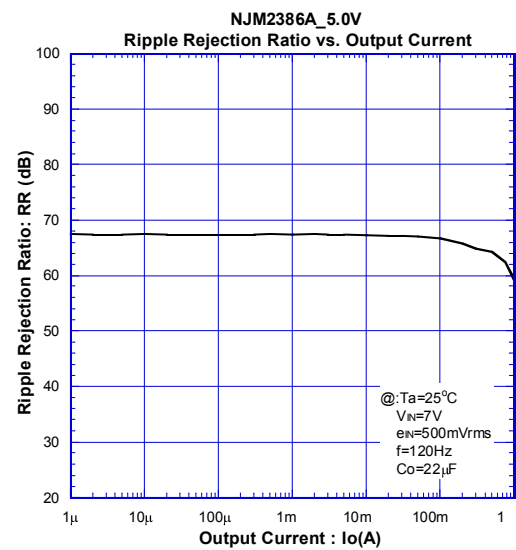
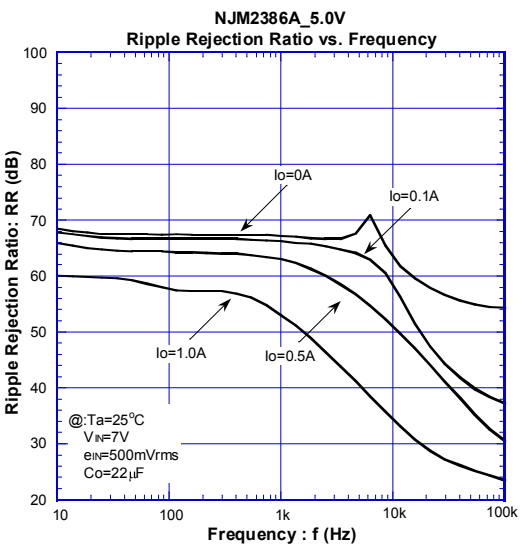
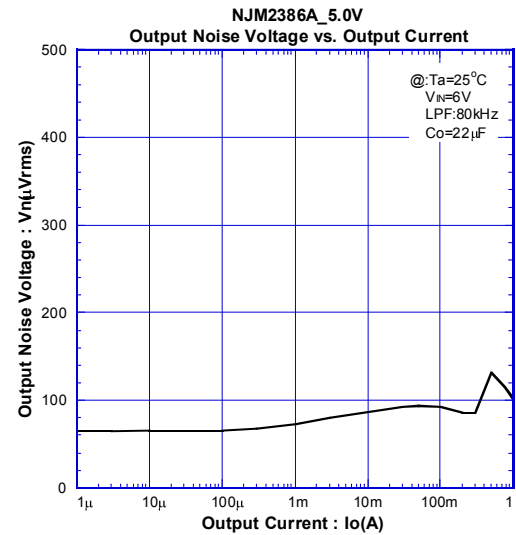
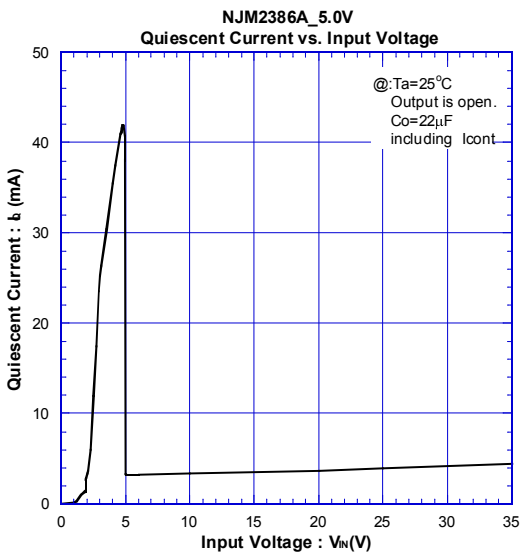
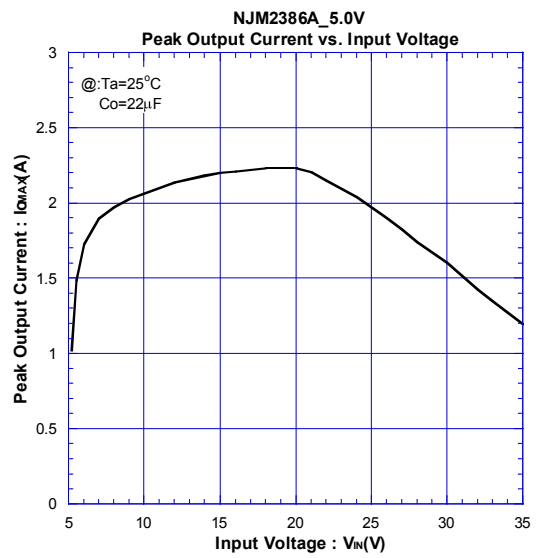
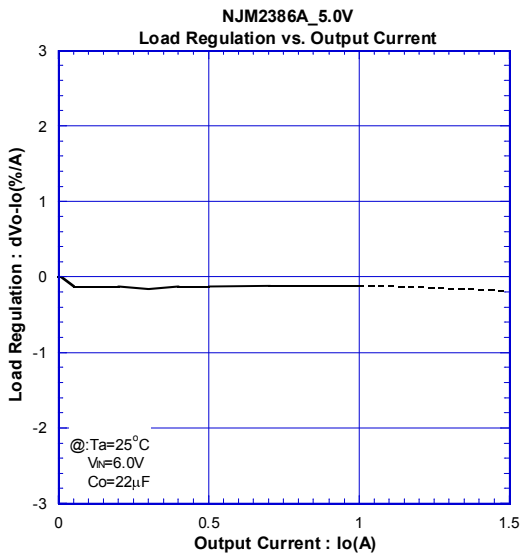

TYPICAL CHARACTERISTICS

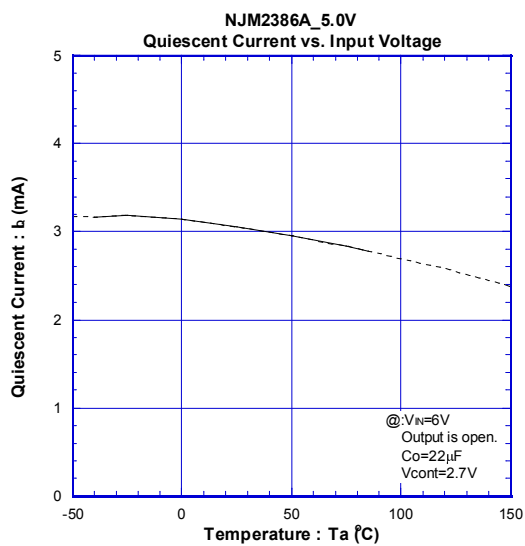
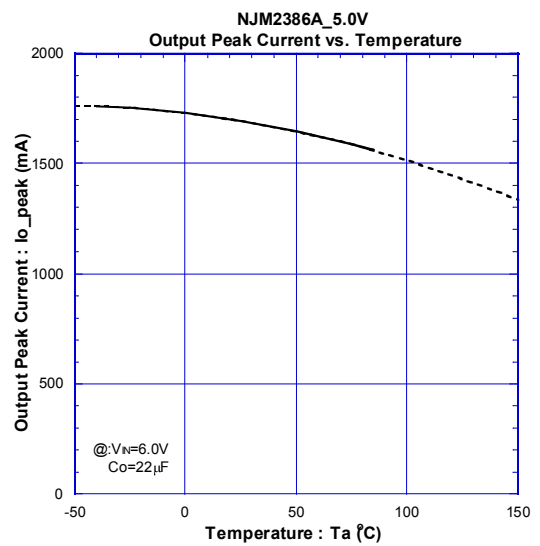
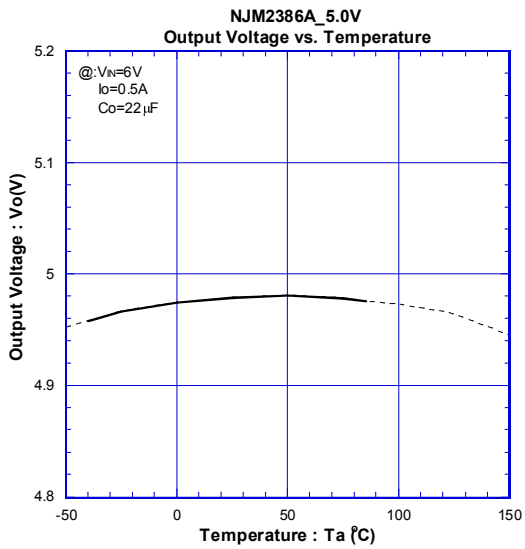
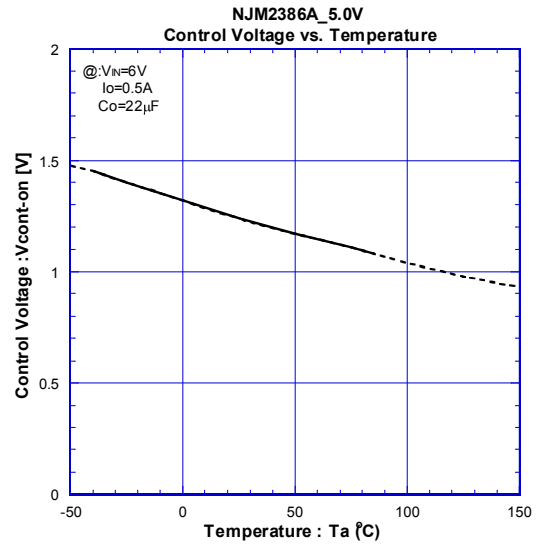
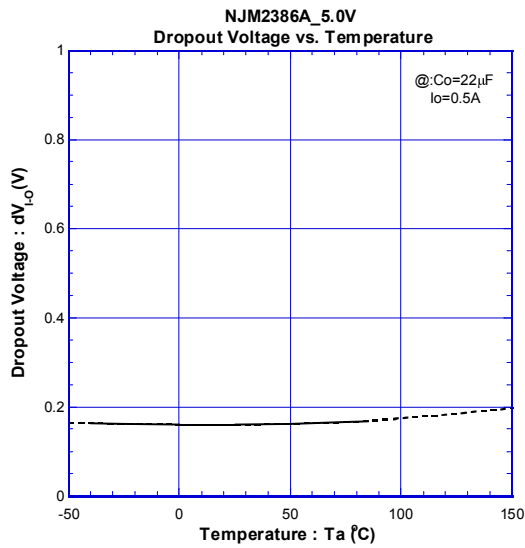

NJM2386A

TYPICAL CHARACTERISTICS

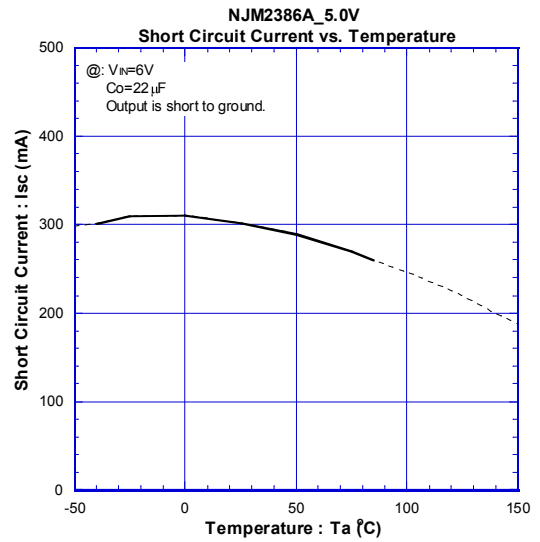
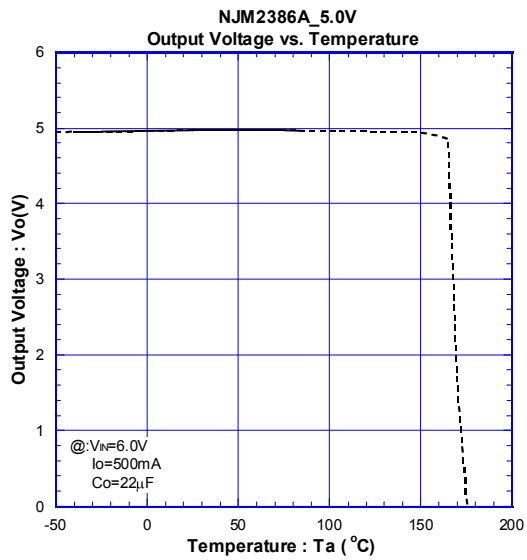
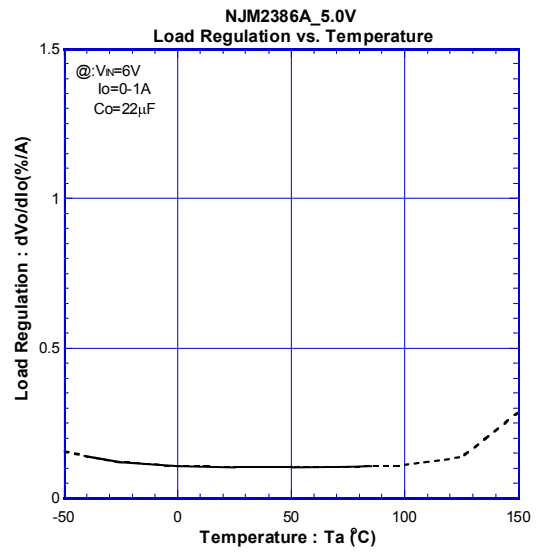
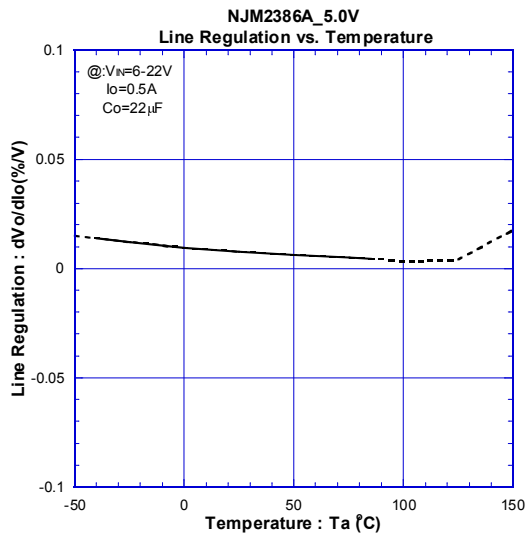

TYPICAL CHARACTERISTICS

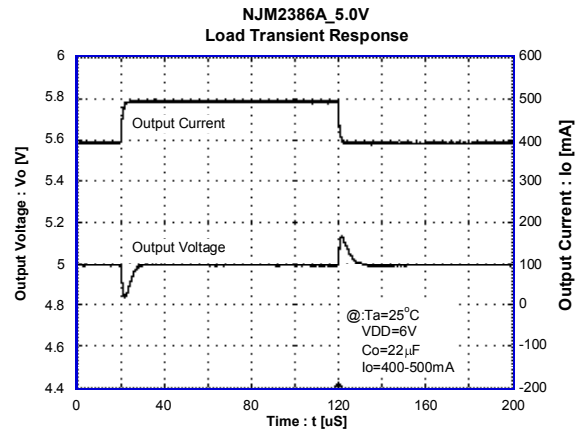
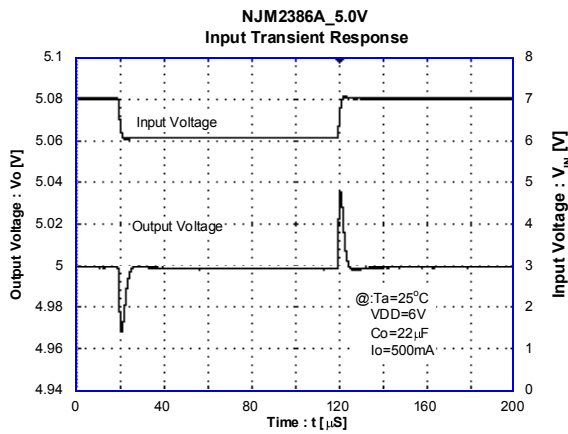
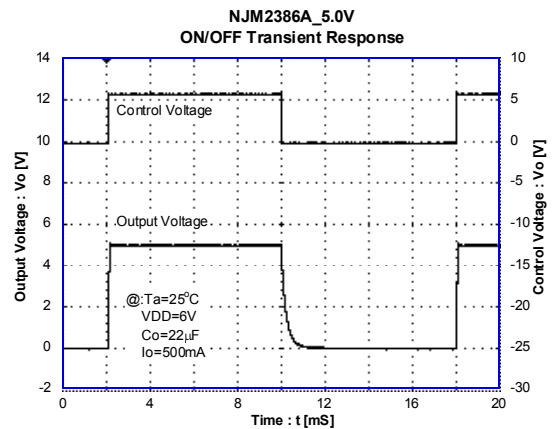
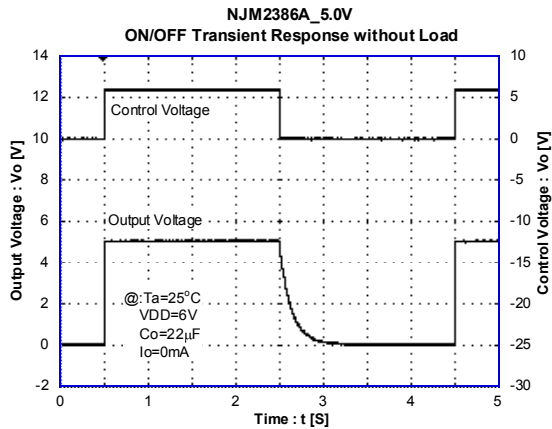

[CAUTION]

The specifications on this databook are only given for information, without any guarantee as regards either mistakes or omissions. The application circuits in this databook are described only to show representative usages of the product and not intended for the guarantee or permission of any right including the industrial rights.