



SPECIFICATION FOR APPROVAL

CUSTOMER	ENDRICH
CUST. PART NO.	
CUST. DOC. REV.	
DESCRIPTION	HIGH CURRENT POWER CHOKE (RoHS+H.F.)
SAMPLE LOT NO.	S201909-0082
PART NO.	MCS1040-XXXXMXX
DOC. REV.	ORIG
DATE	9/11/'19

Once you approve this part, please sign and return this page to the following marked location.

Customer Signature: _____ Date: _____

This part currently development section.

Production line can produce this series of products.

Sales Office-Headquarter

No. 566-1, Kao-Shi Rd., Yangmei, Taoyuan 32668,
Taiwan
TEL: +886-3-475-3355
FAX: +886-3-485-4959

Yong Zhou Plant

Tao-Yuan Rd., Fenghuang Park, Lengshuitan
District, Yongzhou, Hunan 425000, P.R.C.
TEL: +86-746-8610-180
FAX: +86-746-8610-181

Sales Office-Dong Guan,China

No.638,Mei Jing West Road Xiniupo Administrative
Zone Dalang Town,Dong Guan City,GuangDong
Province,China.
TEL: +86-769-8555-0979
FAX: +86-769-8555-0972

TESTED BY	CHECKED BY	APPROVED BY
<i>Gary Chang</i>	<i>Gillian Nan</i>	<i>K.C. Tseng</i>

TABLE OF CONTENTS

INDEX	Page
■ Engineering Change Notice – Record	2
■ Part Number Identification	3
■ Mechanical Dimension	3
■ Marking and Date code	3
■ Electrical Specification	4
■ Electrical Curve	5
■ Reliability Performance	6
■ Reflow Chart	7
■ Packing	8
■ Test Report	

SPECIFICATION FOR APPROVAL

CUSTOMER ENDRICH	CUSTOMER P/N	REV. -	SPL. LOT NO. S201909-0082	
PART NAME HIGH CURRENT POWER CHOKE (RoHS+H.F.)	PART NO. MCS1040-XXXMXX	REV. ORIG	DATE OF ISSUE 9/11/'19	Q'TY 0 PCS

ENGINEERING CHANGE NOTICE – RECORD

REVISION NO.	REVISION DESCRIPTION	AUTHOR	DATE	REMARK
ORIG		<i>Gary Chang</i>	9/11/'19	

SPECIFICATION FOR APPROVAL

✘ This is a RoHS and REACH compliant product whose related documents are available on request.

✘ Graphic is only for dimensionally application.

1. PART NUMBERING IDENTIFICATION

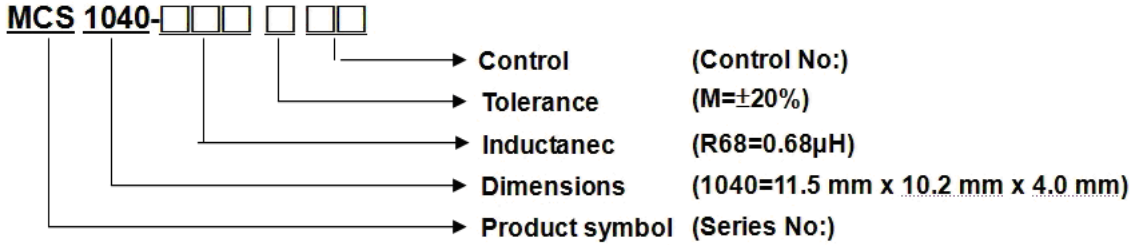

2. MECHANICAL DIMENSION

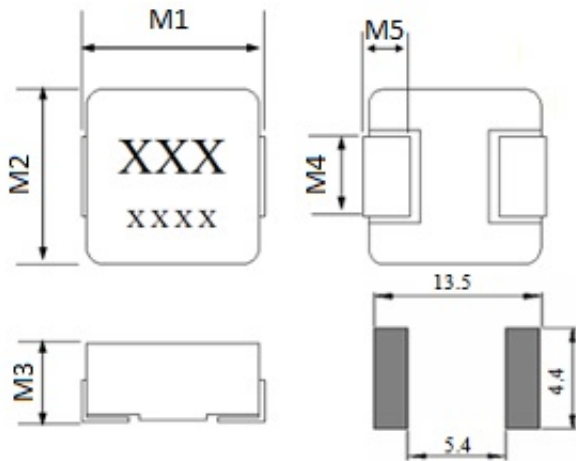

UNIT: mm

	DIM.	TOL.
M1	11.15	±0.35
M2	10.0	±0.3
M3	4.0	MAX.
M4	3.0	±0.5
M5	2.0	±0.5

3. MARKING AND DATE CODE

Marking ex:1.0uH → 1R0

Date code

XX XX → year and weekly ex:1033

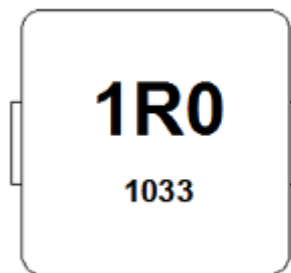

SPECIFICATION FOR APPROVAL

4. ELECTRICAL SPECIFICATION

Part number	Inductance (uH) ±20%	DC Resistance (mΩ) Typical	DC Resistance (mΩ) MAX.	Rated Current (A) Typical	I sat (A) Typical
MCS1040-R22MN1	0.22	0.80	1.0	35.0	50.0
MCS1040-R36MN1	0.36	1.1	1.2	34.0	40.0
MCS1040-R47MN1	0.47	1.3	1.55	25.0	35.0
MCS1040-R56MN1	0.56	1.6	1.8	25.0	32.0
MCS1040-R68MN1	0.68	2.4	2.7	22.0	30.0
MCS1040-1R0MN1	1.0	3.0	3.3	18.0	28.0
MCS1040-1R5MN1	1.5	3.8	4.2	16.0	21.0
MCS1040-2R2MN1	2.2	6.7	7.0	12.0	18.0
MCS1040-3R3MN1	3.3	10.8	11.8	10.0	16.0
MCS1040-4R7MN1	4.7	17.0	20.0	8.5	15.0
MCS1040-6R8MN1	6.8	22.5	25.0	6.5	9.0
MCS1040-8R2MN2	8.2	26.0	29.0	7.0	9.0
MCS1040-100MN1	10	27.0	30.0	7.5	8.5
MCS1040-150MCC	15	40.0	45.0	6.25	7.0
MCS1040-220MCC	22	60.0	66.0	5.0	5.5
MCS1040-330MCC	33	85.0	92.0	4.4	5.0
MCS1040-470MCC	47	130.0	145.0	3.3	3.5
MCS1040-680MN2	68	190.0	200.0	2.5	3.0

TEST INSTRUMENT: CHROMA 16502 、Zentech1320+Zentech3305

NOTE:

1. Test Freq.: 100KHz, 1.0V
2. All test data is referenced to 25°C ambient.
3. Operating Temperature Range -25°C~+125°C.
4. Storage Temperature Range: -20°C~+40°C (60 RH).
5. Rated Current: DC current (A) that will cause an approximate ΔT of 40°C.
6. I sat: DC current (A) that will cause Lo to drop approximately 30%.
7. The part temperature (ambient +temp rise) should not exceed 125°C under worst case operating conditions.
8. Circuit design, component placement, PWB trace size and thickness, airflow and other cooling provisions all affect the part temperature Part temperature should be verified.
9. MSL: Level 1

SPECIFICATION FOR APPROVAL

5. ELECTRICAL CURVE

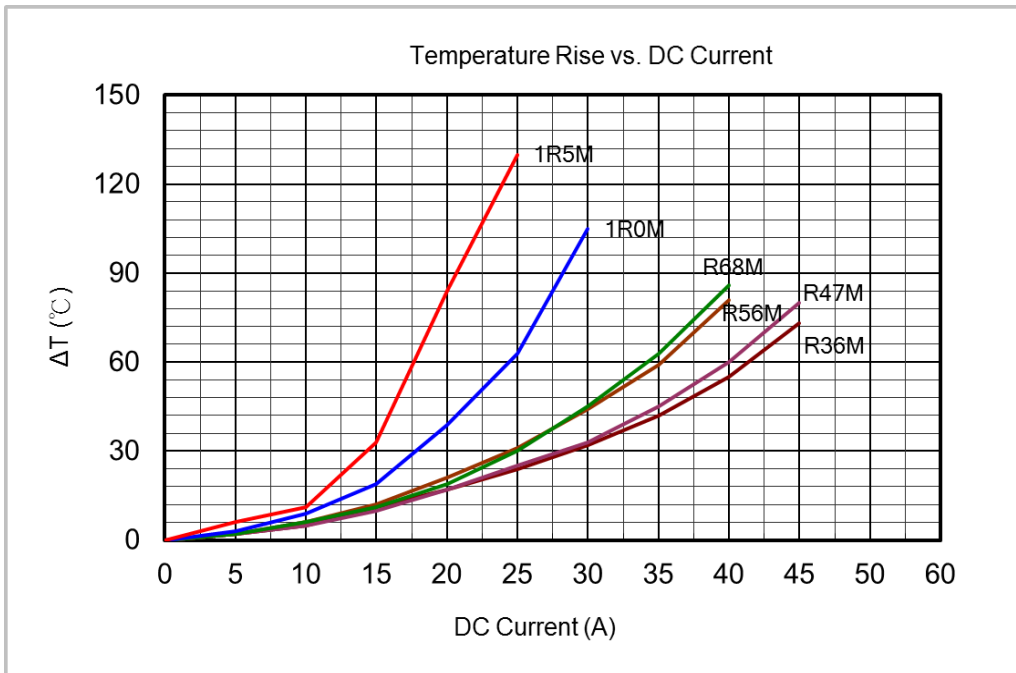
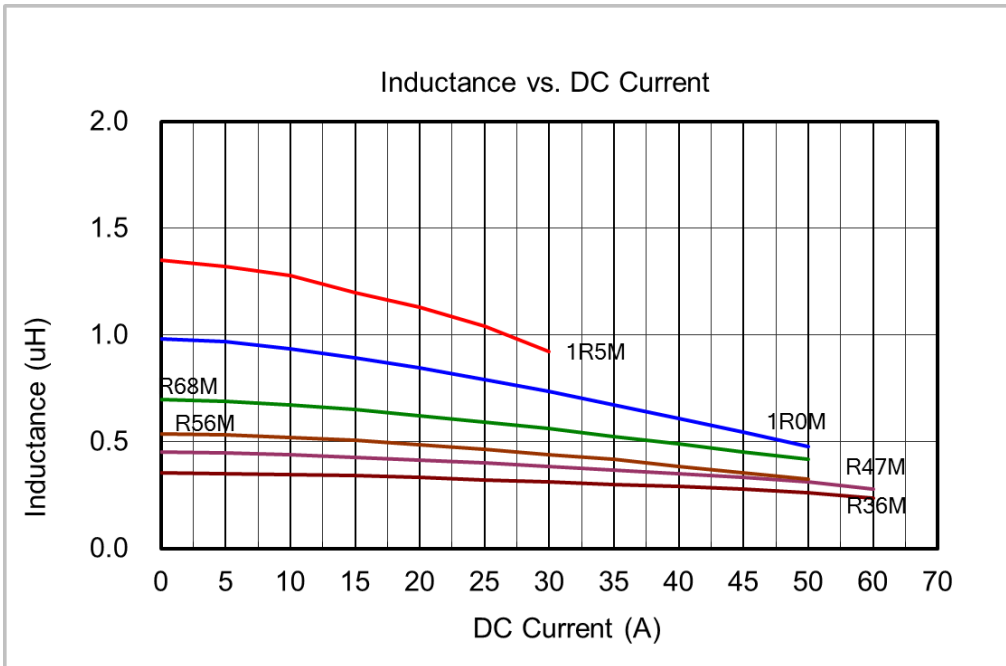

SPECIFICATION FOR APPROVAL

6. RELIABILITY PERFORMANCE

Reliability Experiment For Electrical

Test Item	Accept criteria	Test Condition	Standard Source
Humidity Test	1.Change from an initial value L:within±5% 2.no visible damage.	+40°C ± 2°C, humidity of 90% ±5% (total 96 hours).	MIL-STD-202G Method 103B Test Condition B
High Temperature Test	1.Change from an initial value L:within±5% 2.no visible damage.	1.Temperature: +125°C±2°C. 2.Test time: 48±2hrs.	IEC 68-2 Test Condition B
Low Temperature Test	1.Change from an initial value L:within±5% 2.no visible damage.	1.Temperature: -25°C±2°C. 2.Test time: 48±2hrs.	IEC 68-2 Test Condition A
Thermal Shock	1.Change from an initial value L:within±5% 2.no visible damage.	+125°C±5°C (30 minutes) ~ -55±5°C (30 minutes), temperature switch time: 5 minutes (total 50 cycles) Wind speeds 10m/sec.	Reference MIL-STD-202G Method 107G Test Condition A-2
Life Test	1.Change from an initial value L:within±5% 2.no visible damage.	+70°C±5°C (250Hours).	Reference MIL-STD-202G Method 108A Test Condition B

Reliability Experiment For Physical

Test Item	Accept criteria	Test Condition	Standard Source
Vibration Test	1.Change from an initial value L:within±5% 2.no visible damage.	10-55-10HZ, amplitude: 1.5mm, direction: X, Y, Z axes, each axis 2 hours (total 6 hours).	MIL-STD-202G Method 201A
Solder Heat Resistance Test	1.no visible damage.	IR/convection reflow: Peak Temp 255°C ~260°C for 3~5 Sec. in air, Through 2 Cycle. Temperature Ramp:+1~4°C/sec.; Above 217°C, must keep 90 s - 120 s.	Reference MIL-STD-202G Method 210F Test Condition K (Reflow)
Solder Ability Test	1. Lead must have 95% above coverage.	Soak in 245°C solder pot of 3~5 Sec.	Reference J-STD-002D

SPECIFICATION FOR APPROVAL

7. TYPICAL RoHS REFLOW PROFILE

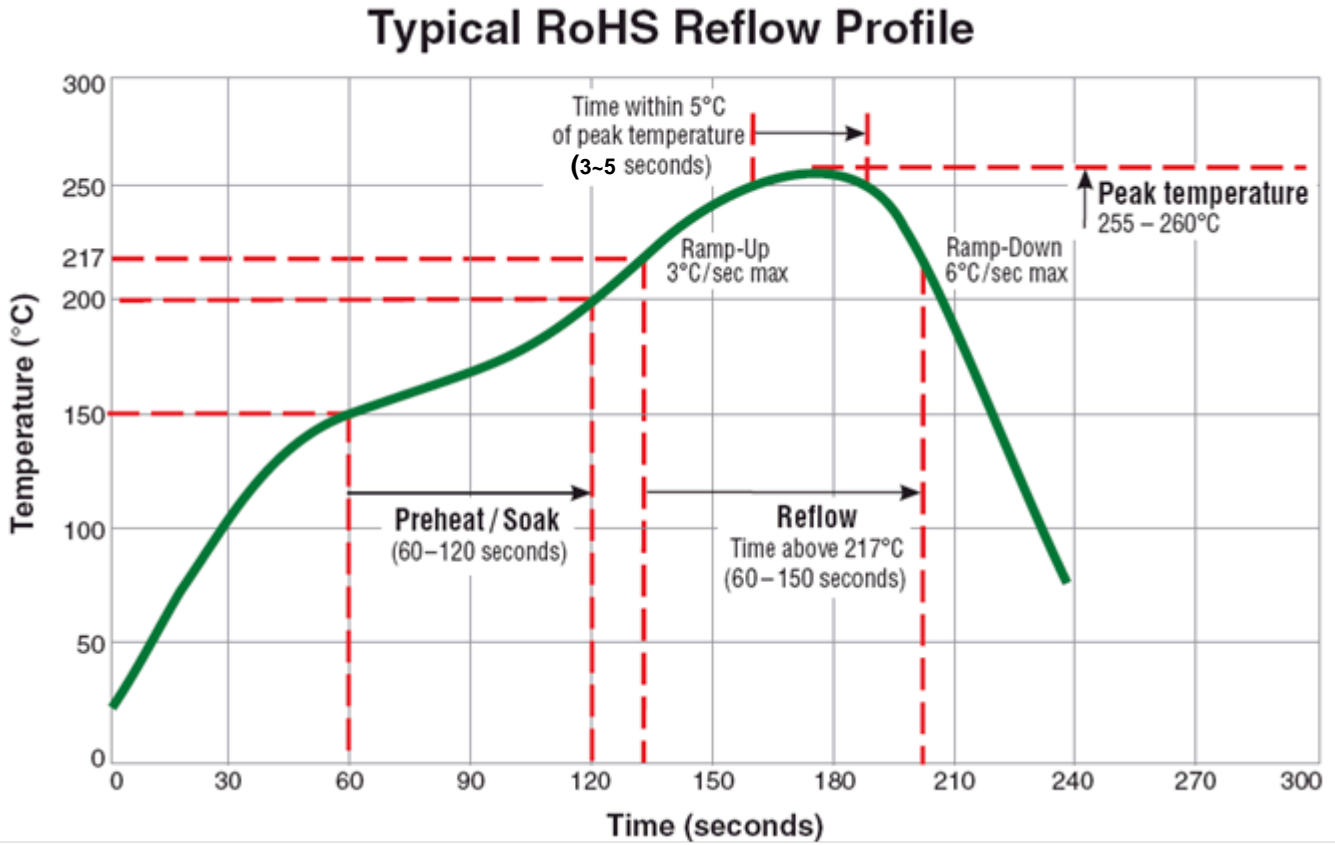

SPECIFICATION FOR APPROVAL

8. PACKING

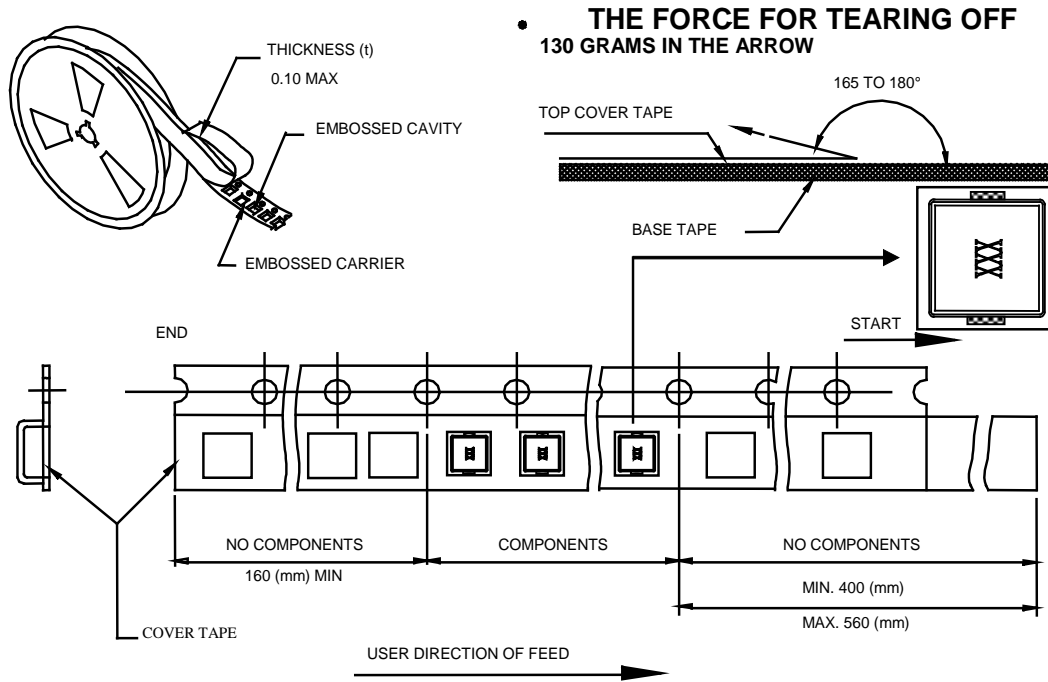

■ CARRIER TAPE REELS (mm)

MATERIAL: PLASTIC

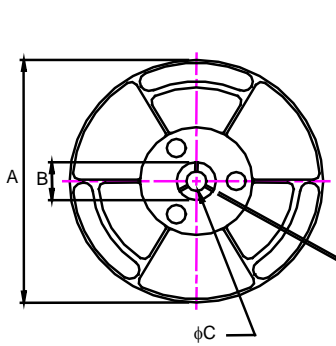

500 Parts per Reel

■ DIMENSIONS OF CARRIER TAPE (mm)

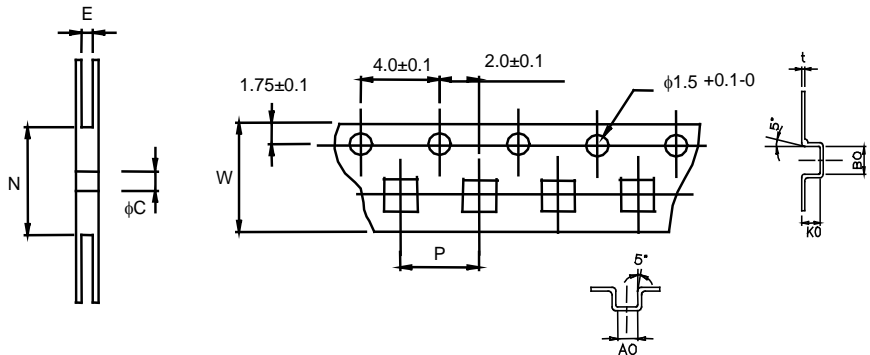

※ 10 sprocket hole pitch cumulative tolerance ± 0.20

UNIT: mm

	A	B	C	E	N	P	W	t	A0	B0	K0
DIM.	330	25.0	13.0	24.6	100	16.0	24.0	0.4	10.6	11.7	4.25
TOL.	± 0.2	± 0.5	± 0.5	± 0.5	MIN	± 0.1	± 0.3	± 0.05	± 0.1	± 0.1	± 0.1