

L05016i	LED Driver 20W, 3-32 Vdc, 1x 250-1000 mA / 2x250-500 mA	L1W2MLT100S-20E
L05016Ci	LED Driver 20W, 3-43 Vdc, 1x 110-500 mA	L1W1MLT500S-20E
L05016CiD	LED Driver 20W, 3-45 Vdc, 2x100-300 mA / 1x 200-600mA	L1W2MLT600S-20E

Engineered for Best Fixture Performance

Fulham LumoSeries drivers are all built on core engineering design principles for exceptional standards of performance and reliability in LED systems. Highest-grade critical components together with design features for thermal management ensure excellent reliability. Our low ripple designs create flicker-free lighting and perfectly smooth dimming. Simplicity of specification and installation is a key characteristic of all Fulham LumoSeries drivers. Hence the wide voltage and current ranges and industry leading low inrush current.



Ultimate flexibility with step less adjustable current, dual output channel and multiple dimming options.

Engineered for Performance

- Industry leading efficiency
- Excellent EMC behavior
- Very high power factor

Engineered for Reliability

- Low inrush current
- Thermal protection (automatic current limiter)
- Short and open circuit protection, overload and overvoltage protection

Engineered for Simplicity

- Wide voltage and current range enabling many applications with just one driver product.
- Step less current adjustment allowing to fine-tune light output post installation.

5 year warranty

Fulham LumoSeries takes pride in the quality of its products. We not only develop all products in house, they are also produced to ensure guaranteed reliability and performance. Fulham LumoSeries drivers come with the assurance of a 5 year warranty. After all, with typical LED lifetimes of 50,000 hours, it is critical to have a power supply with equal reliability.



Product features

- Wide output voltage range 3 - 43 Vdc, ideally suited for driving CoB LED arrays
- Wide range of current settings
- Dual current output (on the L05016i and -CiD)
- 0-10V-, 1-10V-, potentiometer- and pulse dimming
- Max inrush current 1.25 A
- Dual stage topology
- Low output current ripple (<1 %) at 100 Hz
- Thermal protection: dimming instead of switch off
- Active output overvoltage protection
- Up to 85 % efficiency across a wide range of loads
- Power factor 0.9C
- SELV
- ENEC certified
- Engineered and Manufactured in Europe

Certificates and standards

- ENEC05, CE
- EN55015 / EN61000-3-2 / EN61347-2-13 / EN61347-1 / EN61547 / EN62384 / SELV

Classifications



Dimming

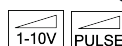

* Class II, enhanced insulation, when used with strain relieve
 ** Class II, reinforced insulation, when built in without strain relieve.

Specific technical data

Type	Efficiency at full load	Output current	Output voltage range	Open circuit output voltage	Minimum dimlevel
L05016i	85 %	1x 250 - 1000 mA or 2 x 250 - 500 mA	3 – 32 Vdc	33 Vdc	15 mA - off
L05016Ci	85 %	110 - 500 mA	3 – 43 Vdc	43 Vdc	15 mA - off
L05016CiD	84 %	2 x 100 - 300 mA or 1 x 200 - 600 mA	3 – 45 Vdc	50 Vdc	20 mA - off

Technical data

Rated supply voltage	220-240 Vac
Input voltage	110-240 Vac / 150-375 Vdc*
Mains frequency	50/60 Hz
Output current tolerance	5%
100 Hz ripple current	<1%
Power factor at full load	0.9C
Standby power	200 mW
Max. Output power	20 W
Nominal line current at 240 Vac	200 mA
Dimming	0/1 – 10V, potentiometer 100K log b, pulse (SELV)
Dimming method	PWM 230 Hz
Nonvolatile memory	No
Startup time	< 10ms
Warm up time to 95% of light output	< 50ms
Output isolation	SELV
Surge protection (diff. / comm.)	2 kV / 6 kV
IP classification	IP 20
Circuit lifetime	50,000 hrs at Tc max.
Case dimensions	110 x 52 x 23.5 mm
Case material	Polyamide 6 (PA6)

* External DC fuse is required

Dimensions

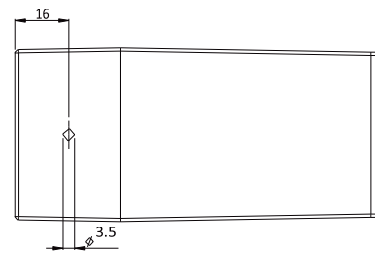
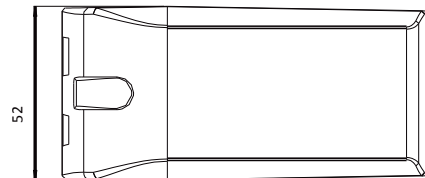
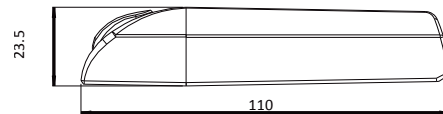

Inrush current

Mains max. peak inrush at full load	1.17A per driver on phase 60° (average starting angle)*
	2.08A per driver on phase 90° (worst case starting angle)*
	1.21A per driver on phase 60° (average starting angle)**
	4.49A per driver on phase 90° (worst case starting angle)**

** Tested at 240 Vac 1 driver connected, with TTI HA1600A analyzer.

* Tested at 240 Vac 10 drivers parallel connected, with TTI HA1600A analyzer.

Maximum number of drivers on automatic circuit breakers

Automatic circuit breaker type	C10	C13	C16	C20	B10	B13	B16	B20
L05016, L05016Ci, L05016CiD	82	106	131	163	82	106	131	163

Thermal specifications

Ambient temperature range (Ta)	-20 to 50°C
Maximum case temperature (Tc)	< 85°C
Storage temperature range	-20 to 50°C

Overload protection

If the maximum output power is exceeded, the LED driver reduces the LED output current. After elimination of the overload the nominal operation is restored automatically.

Over temperature protection

The LED driver is protected against thermal overload. If the temperature limit is exceeded, the output current is reduced.

Overcurrent protection

Overcurrent protection to allow hot swapping of LEDs higher than 3 Watt.

LED load

Fulham LumoSeries LED drivers are designed to drive passive LEDs, -COB's and -LED assemblies
Proper function is not guaranteed when (LED)loads with active components are used.

Forward voltage

The LED voltage of channel one must always be equal or higher than the LED voltage of channel two
When only one output is used, always use output one.

Short-circuit protection

In case of a short circuit the LED driver switches to protection mode. After the removal of the short-circuit the LED driver will recover automatically.

No-load operation

In no-load operation the output voltage will not exceed the specified open circuit output voltage.

Unexpected behavior when using 0-10V/ 1-10V

When controlling the driver with a 0-10V/ 1-10V system it can occur that the 0/1-10V controller delivers (or allows) a voltage that is higher than 12V. The voltage triggers the driver in to 'pulse switch mode'. This will result in unexpected and unintended behavior of the LED's. In case of symptoms like these, it is sufficient to clamp the output of the control system with a 10 or 12V zener diode. (cathode to the positive).
To prevent this from happening always use a system / dimmer which complies with EN60929 Annex E

Wiring diagram

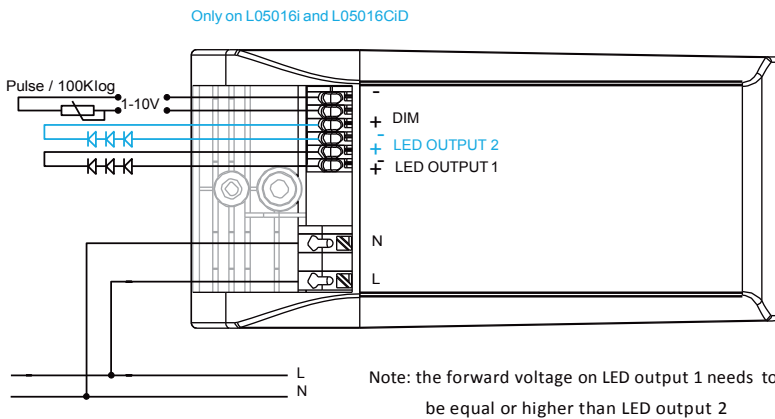

Wiring of device

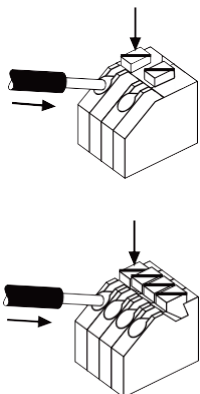

Solid

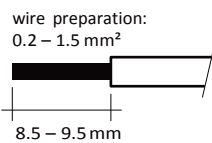

Stranded

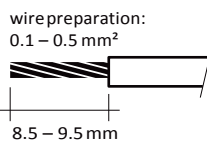
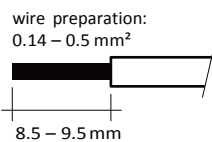
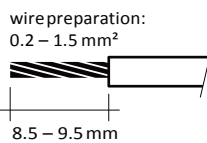

Strain relief

The strain relief inserts can be removed to accommodate wiring of larger diameters.

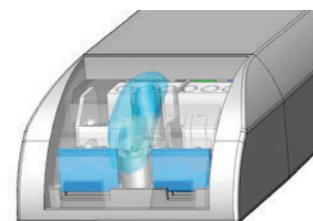

Dimming

The L05016 series can be switched on/off and dimmed by using the dim input.

The driver automatically detects Whether a 0/1-10V, potentiometer or puls switch is connected.

Pulse dimming

In case of multiple drivers on one dimmer make sure that the wires are fixed according to polarity.

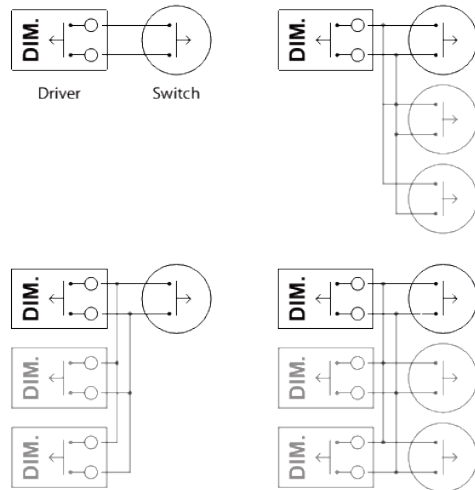

0-10V / 1-10 V / potentiometer dimming

In case of multiple drivers on one dimmer make sure that the wires are fixed according to polarity.

The L05016 series can be switched on/off and dimmed by using 1-10V dim input.

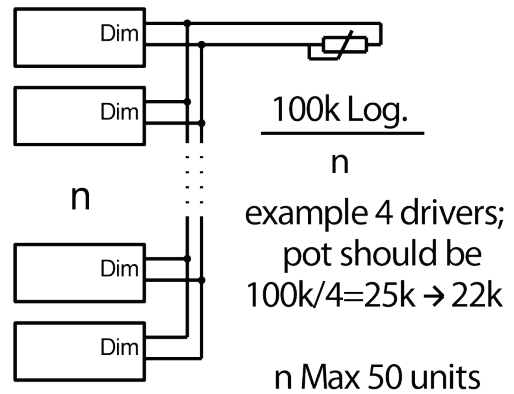

Connection scheme L05016CiD parallel

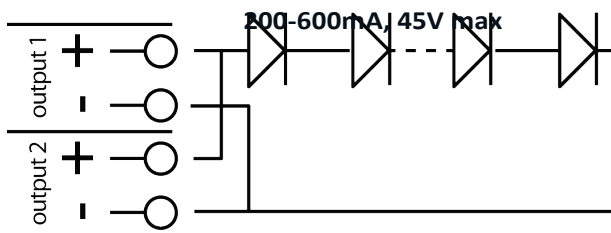

The outputs of the L05016CiD can be switched parallel, the output current then will be 200-600mA. This is twice the value as indicated on the driver.
The output voltage range is 3-45Vdc.
The maximum output power is 20W.

Ordering data

Part	Part number	Alternate Part number	EAN code	Packaging carton	Multibox carton	Weight per piece
L05016i LED Driver 20W, 3-32 Vdc, 1x 250-1000 mA or 2x250-500 mA	L05016i	L1W2MLT100S-20E	8718801703243	20 pieces	240 pieces	110g
L05016Ci LED Driver 20W, 3-43 Vdc, 110-500 mA	L05016Ci	L1W1MLT500S-20E	8718801703229	20 pieces	240 pieces	110g
L05016CiD LED Driver 20W, 3-45 Vdc, 2x100-300 mA or 1x 200-600mA	L05016CiD	L1W2MLT600S-20E	8718801703236	20 pieces	240 pieces	110g

Berenkoog 56
 NL-1822 BZ Alkmaar
 The Netherlands

www.Fulham.com

© 2017, Fulham Company All rights reserved. Designs and specifications may change without prior notice. Fulham products are not designed, intended, or authorized for any application in which the failure of the product could cause personal injury.