



# CT1010-W, CT1011-W, CT1012-W, CT1013-W, CT1014-W CT1015-W, CT1016-W, CT1017-W, CT1018-W, CT1019-W DC Input 4-Pin Long Mini-Flat Phototransistor Optocoupler

## Features

- High isolation 5000 VRMS
- CTR flexibility available see order information
- Extra low coupling capacitance
- DC input with transistor output
- Temperature range - 55 °C to 125 °C
- External creepage distance > 8 mm
- Internal creepage distance > 4.6 mm
- Distances through insulation > 0.4 mm
- Green Package
- Regulatory Approvals
  - UL - UL1577 (E364000)
  - VDE - EN60747-5-5(VDE0884-5)
  - CQC – GB4943.1, GB8898
  - IEC60065, IEC60950

## Applications

- Switch mode power supplies
- Computer peripheral interface
- Microprocessor system interface

## Description

The CT1010-W, CT1011-W, CT1012-W, CT1013-W, CT1014-W, CT1015-W, CT1016-W, CT1017-W, CT1018-W, CT1019-W consists of a photo transistor optically coupled to a gallium arsenide Infrared-emitting diode in a 4-lead SOP Package.

## Package Outline

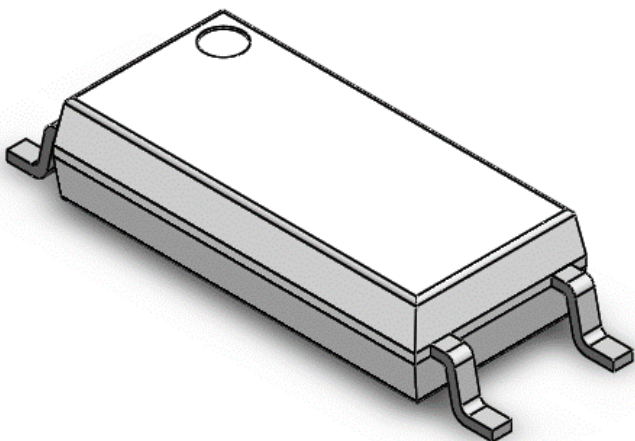

## Schematic

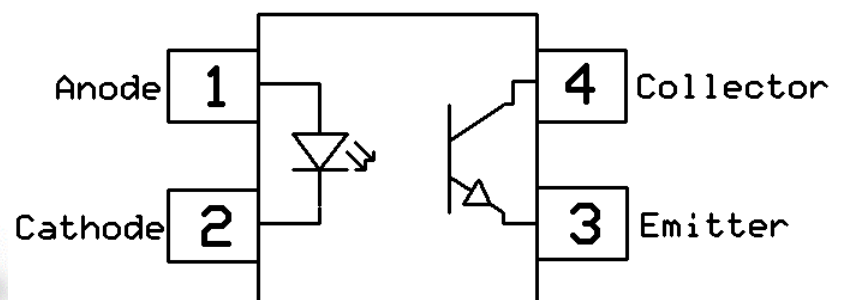



CT1010-W, CT1011-W, CT1012-W, CT1013-W, CT1014-W  
CT1015-W, CT1016-W, CT1017-W, CT1018-W, CT1019-W  
DC Input 4-Pin Long Mini-Flat Phototransistor Optocoupler

### Absolute Maximum Rating at 25°C

<i>Symbol</i>	<i>Parameters</i>	<i>Ratings</i>	<i>Units</i>	<i>Notes</i>
V <sub>ISO</sub>	Isolation voltage	5000	V <sub>RMS</sub>	
T <sub>OPR</sub>	Operating temperature	-55 ~ +125	°C	
T <sub>STG</sub>	Storage temperature	-55 ~ +150	°C	
T <sub>SOL</sub>	Soldering temperature	260	°C	
<b>Emitter</b>				
I <sub>F</sub>	Forward current	50	mA	
I <sub>F(TRANS)</sub>	Peak transient current (≤1μs P.W,300pps)	1	A	
V <sub>R</sub>	Reverse voltage	6	V	
P <sub>D</sub>	Power dissipation	85	mW	
<b>Detector</b>				
P <sub>C</sub>	Power dissipation	150	mW	
B <sub>VCEO</sub>	Collector-Emitter Breakdown Voltage	80	V	
B <sub>VECO</sub>	Emitter-Collector Breakdown Voltage	7	V	
I <sub>C</sub>	Collector Current	50	mA	

### Thermal Characteristics

<i>Symbol</i>	<i>Parameters</i>	<i>Ratings</i>	<i>Units</i>	<i>Notes</i>
R <sub>θJA</sub>	Thermal Resistance Junction-Ambient	445	°C/W	
T <sub>J</sub>	Junction temperature	125	°C	



**CT1010-W, CT1011-W, CT1012-W, CT1013-W, CT1014-W  
CT1015-W, CT1016-W, CT1017-W, CT1018-W, CT1019-W  
DC Input 4-Pin Long Mini-Flat Phototransistor Optocoupler**

**Electrical Characteristics**  $T_A = 25^\circ\text{C}$  (unless otherwise specified)

**Emitter Characteristics**

Symbol	Parameters	Test Conditions	Min	Typ	Max	Units	Notes
$V_F$	Forward voltage	$I_F = 10\text{mA}$		1.26	1.4	V	
		$I_F = 50\text{mA}$	-	1.42	1.5	V	
$I_R$	Reverse Current	$V_R = 6\text{V}$	-	-	5	$\mu\text{A}$	
$C_{IN}$	Input Capacitance	$f = 1\text{kHz}$	-	45	-	pF	

**Detector Characteristics**

Symbol	Parameters	Test Conditions	Min	Typ	Max	Units	Notes
$B_{V_{CEO}}$	Collector-Emitter Breakdown	$I_C = 100\mu\text{A}$	80	-	-	V	
$B_{V_{ECO}}$	Emitter-Collector Breakdown	$I_E = 100\mu\text{A}$	7	-	-	V	
$I_{CEO}$	Collector-Emitter Dark Current	$V_{CE} = 20\text{V}, I_F = 0\text{mA}$	-	-	100	nA	

**Transfer Characteristics**

Symbol	Parameters	Test Conditions	Min	Typ	Max	Units	Notes		
CTR	Current Transfer Ratio	CT1012-W	$I_F = 1\text{mA}, V_{CE} = 5\text{V}$	22	-	-	%		
		CT1013-W		34	-	-			
		CT1014-W		56	-	-			
		CT1011-W	$I_F = 10\text{mA}, V_{CE} = 5\text{V}$	60	-	300			
		CT1012-W		63	-	125			
		CT1013-W		100	-	200			
		CT1014-W		160	-	320			
		CT1010-W		$I_F = 5\text{mA}, V_{CE} = 5\text{V}$	50	-		600	
		CT1015-W			50	-		150	
		CT1016-W	100		-	300			
		CT1017-W	80		-	160			
		CT1018-W	130		-	260			
		CT1019-W	200	-	400				
$V_{CE(SAT)}$	Collector-Emitter Saturation Voltage	$I_F = 10\text{mA}, I_C = 1\text{mA}$	-	-	0.4	V			
$R_{IO}$	Isolation Resistance	$V_{IO} = 500\text{V}_{DC}$	$5 \times 10^{10}$			$\Omega$			
$C_{IO}$	Isolation Capacitance	$f = 1\text{MHz}$			1	pF			



**CT1010-W, CT1011-W, CT1012-W, CT1013-W, CT1014-W  
CT1015-W, CT1016-W, CT1017-W, CT1018-W, CT1019-W  
DC Input 4-Pin Long Mini-Flat Phototransistor Optocoupler**

---

**Electrical Characteristics**  $T_A = 25^\circ\text{C}$ ,  $V_{CC} = 5\text{V}$  (unless otherwise specified)

**Switching Characteristics**

<b>Symbol</b>	<b>Parameters</b>	<b>Test Conditions</b>	<b>Min</b>	<b>Typ</b>	<b>Max</b>	<b>Units</b>	<b>Notes</b>
$T_{ON}$	Turn On Time	$I_C = 5\text{mA}$ , $V_{CE} = 5\text{V}$ , $R_L = 100\Omega$	-	4.8	22	$\mu\text{s}$	
$T_{OFF}$	Turn Off Time		-	4.2	22		
$t_r$	Rise Time		-	2.7	18		
$t_f$	Fall Time		-	4	18		



# CT1010-W, CT1011-W, CT1012-W, CT1013-W, CT1014-W CT1015-W, CT1016-W, CT1017-W, CT1018-W, CT1019-W DC Input 4-Pin Long Mini-Flat Phototransistor Optocoupler

## Typical Characteristic Curves

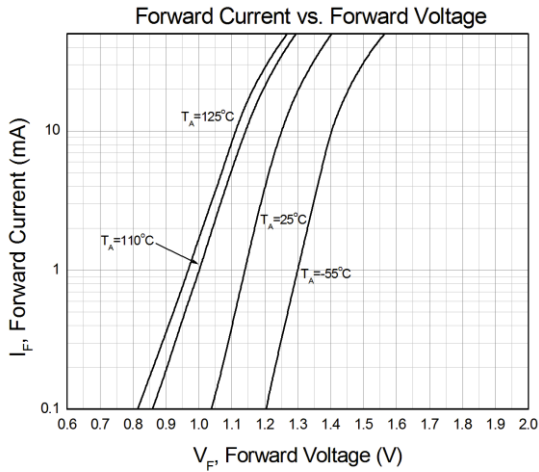

Figure 1

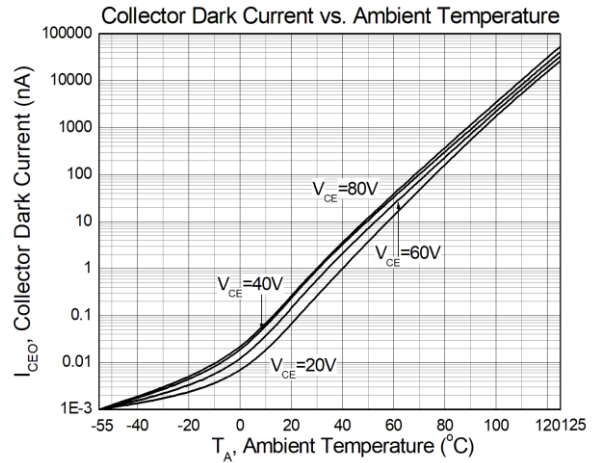

Figure 2

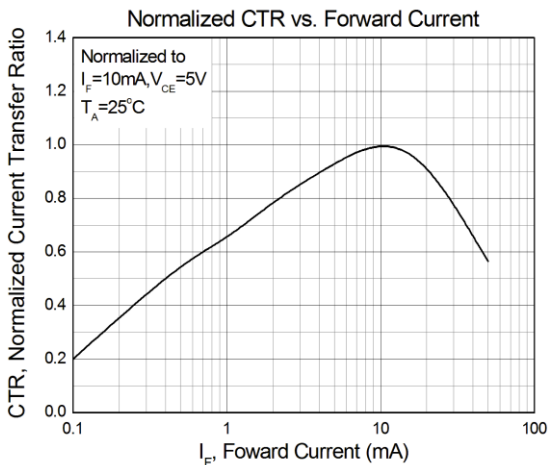

Figure 3

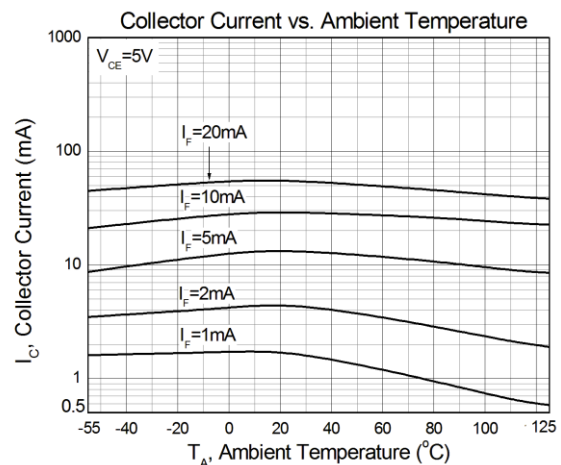

Figure 4

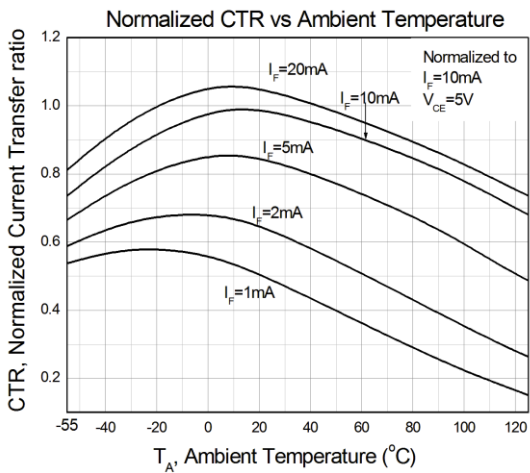

Figure 5

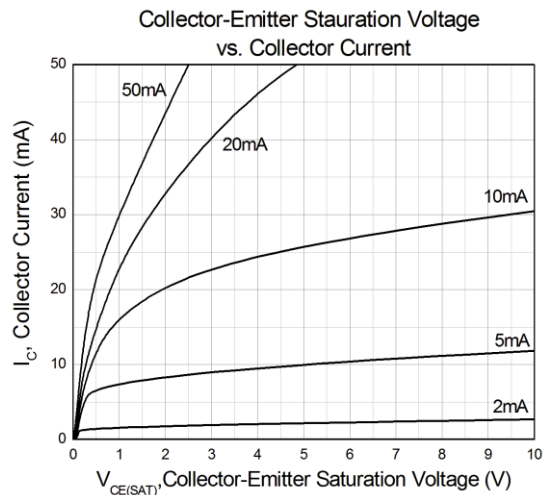
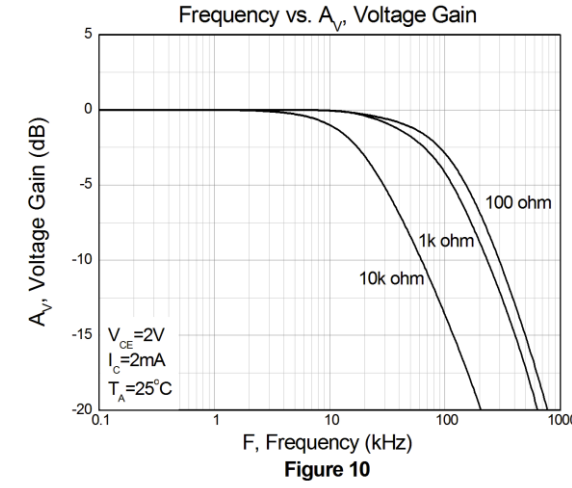
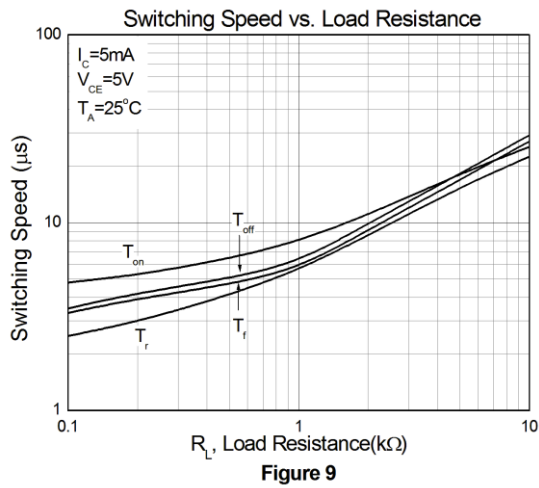
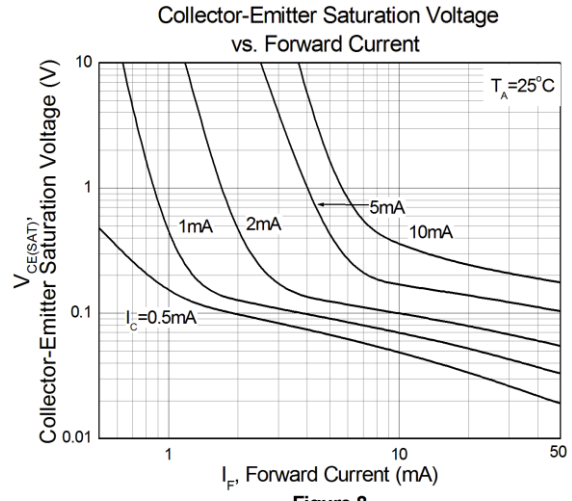
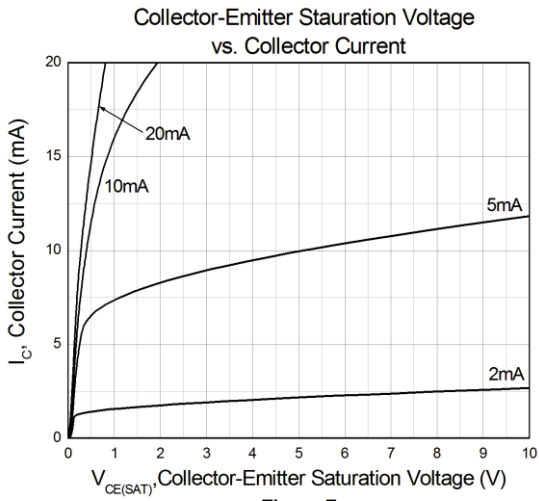

Figure 6



# CT1010-W, CT1011-W, CT1012-W, CT1013-W, CT1014-W CT1015-W, CT1016-W, CT1017-W, CT1018-W, CT1019-W DC Input 4-Pin Long Mini-Flat Phototransistor Optocoupler





CT1010-W, CT1011-W, CT1012-W, CT1013-W, CT1014-W  
CT1015-W, CT1016-W, CT1017-W, CT1018-W, CT1019-W  
DC Input 4-Pin Long Mini-Flat Phototransistor Optocoupler

**Package Dimension** *Dimensions in mm unless otherwise stated*

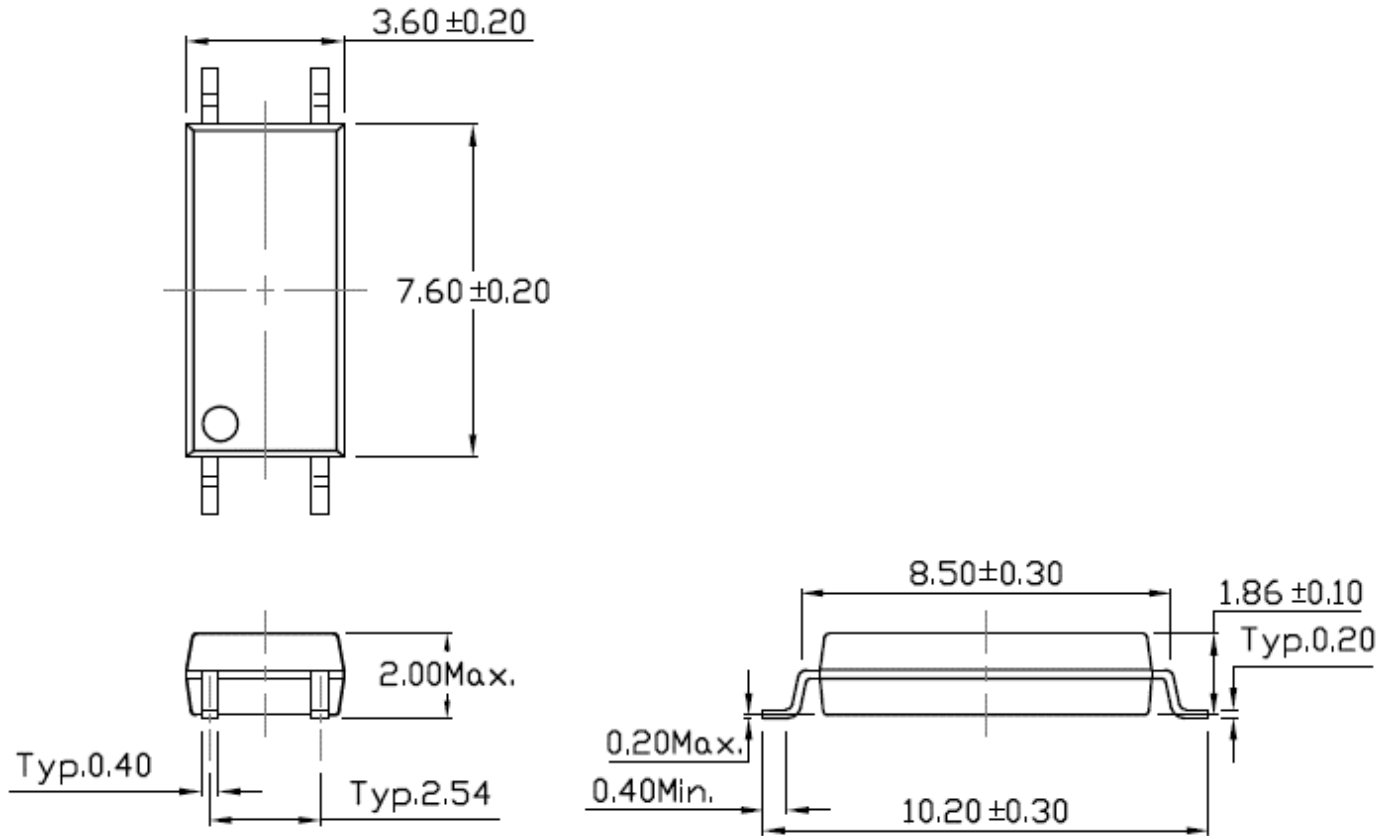

**Recommended Solder Mask** *Dimensions in mm unless otherwise stated*

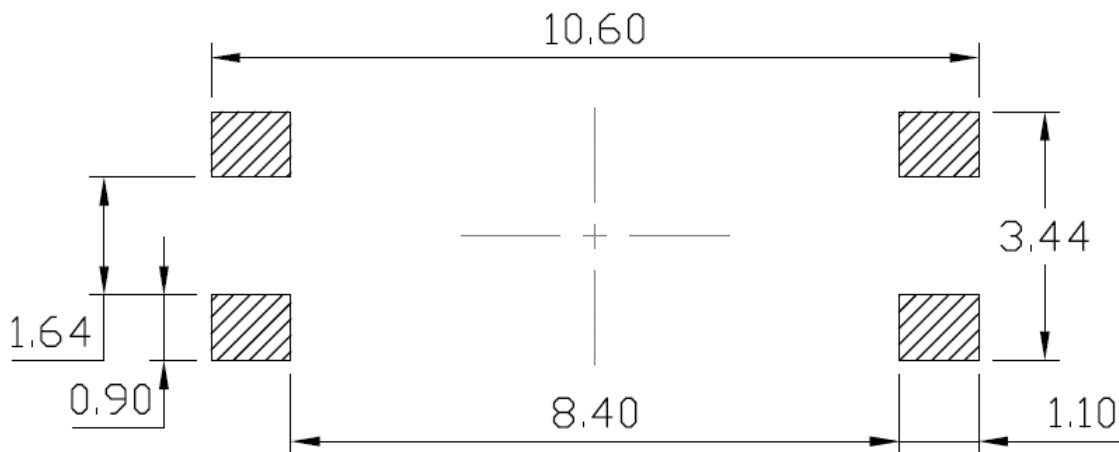



CT1010-W, CT1011-W, CT1012-W, CT1013-W, CT1014-W  
CT1015-W, CT1016-W, CT1017-W, CT1018-W, CT1019-W  
DC Input 4-Pin Long Mini-Flat Phototransistor Optocoupler

## Marking Information



**Note:**

- CT : Denotes "CT Micro"
- 1019 : Part Number
- Y : Fiscal Year
- V : VDE safety mark (option)
- WW : Work Week
- K : Manufacturing Code

## Ordering Information

### CT101X(V)(Y) -W

- X = Part No. (0,1,2,3,4,5,6,7,8,9)
- V = VDE safety mark option (V or none)
- Y = Tape and reel option (T1 or T2)
- W = Outline Color (W, White)

<b>Option</b>	<b>Description</b>	<b>Quantity</b>
T1	Surface Mount Lead Forming – With Option 1 Taping	3000Units/Reel
T2	Surface Mount Lead Forming – With Option 2 Taping	3000Units/Reel





CT1010-W, CT1011-W, CT1012-W, CT1013-W, CT1014-W  
CT1015-W, CT1016-W, CT1017-W, CT1018-W, CT1019-W  
DC Input 4-Pin Long Mini-Flat Phototransistor Optocoupler

**Carrier Tape Specifications** *Dimensions in mm unless otherwise stated*

**Option T1**

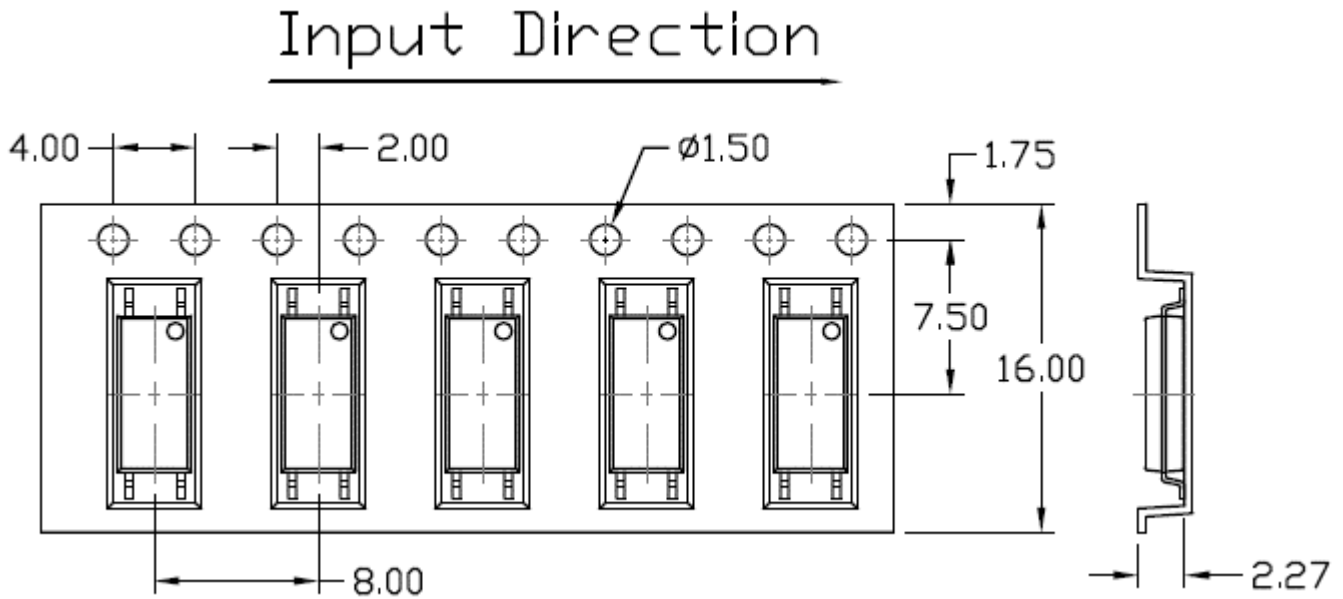

**Option T2**

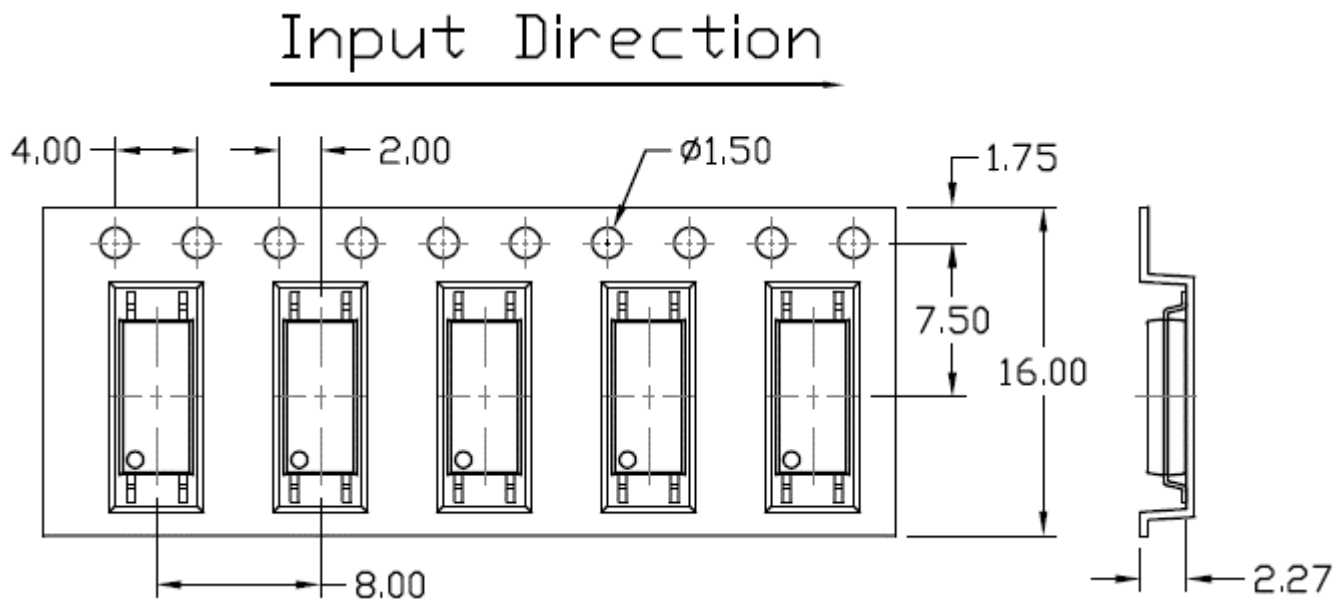



CT1010-W, CT1011-W, CT1012-W, CT1013-W, CT1014-W  
CT1015-W, CT1016-W, CT1017-W, CT1018-W, CT1019-W  
**DC Input 4-Pin Long Mini-Flat Phototransistor Optocoupler**

**Wave soldering** (JEDEC22A111 compliant)

One time soldering is recommended within the condition of temperature.

Temperature:  $260 \pm 5^\circ\text{C}$ .

Time: 10 sec.

Preheat temperature: 25 to  $140^\circ\text{C}$ .

Preheat time: 30 to 80 sec.

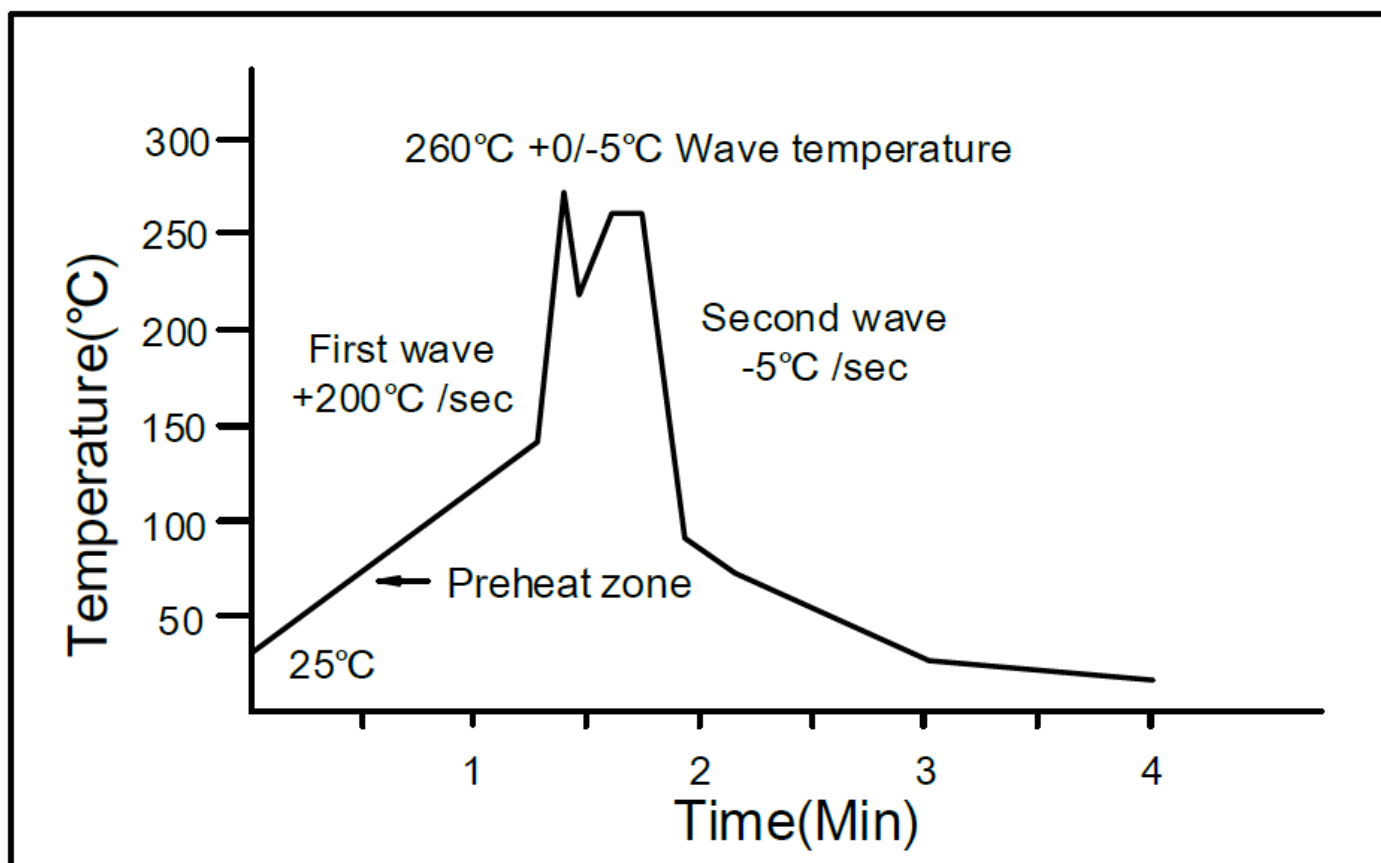

**Hand soldering by soldering iron**

Allow single lead soldering in every single process.

One time soldering is recommended. Temperature:  $350 \pm 5^\circ\text{C}$

Time: 3 sec max.



**CT1010-W, CT1011-W, CT1012-W, CT1013-W, CT1014-W  
CT1015-W, CT1016-W, CT1017-W, CT1018-W, CT1019-W  
DC Input 4-Pin Long Mini-Flat Phototransistor Optocoupler**

**Reflow Profile**

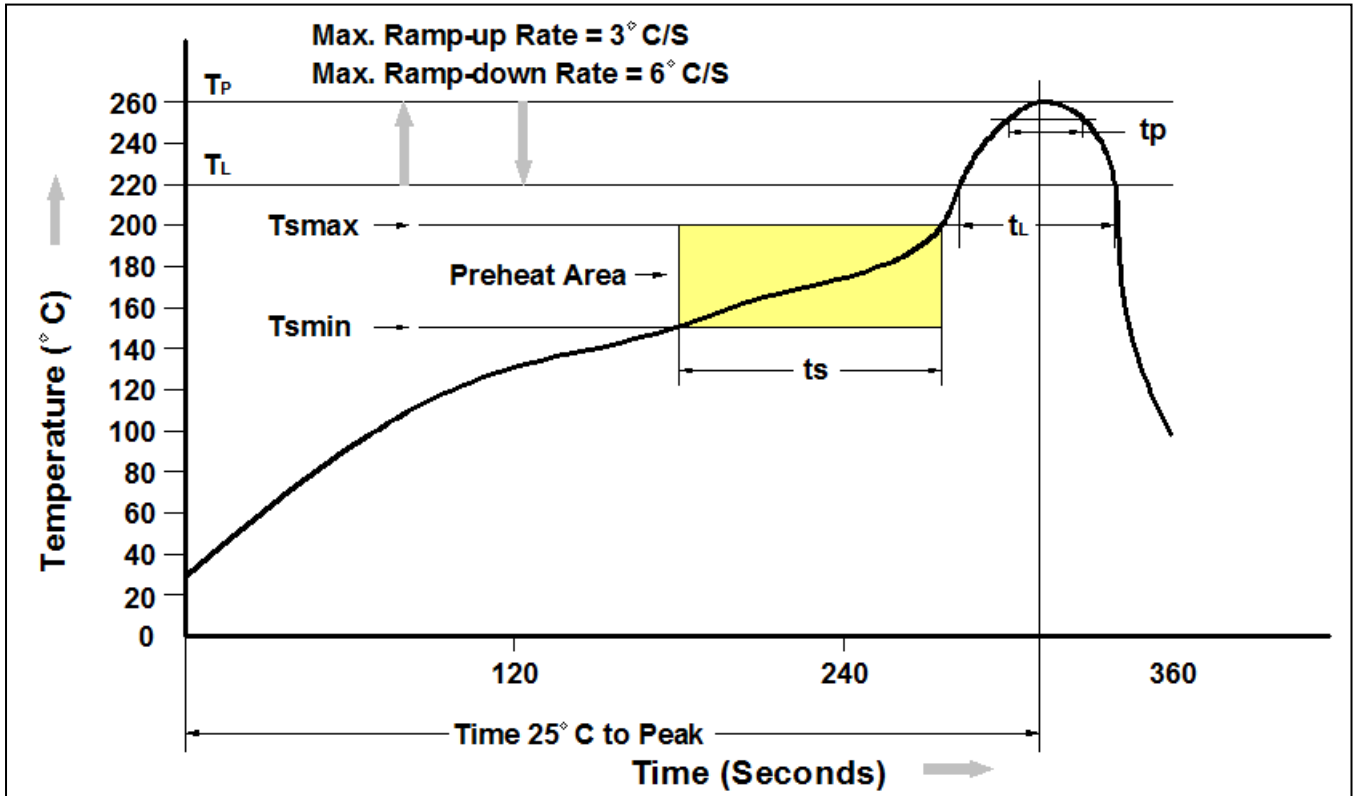

Profile Feature	Pb-Free Assembly Profile
Temperature Min. (T <sub>smin</sub> )	150°C
Temperature Max. (T <sub>smax</sub> )	200°C
Time (t <sub>s</sub> ) from (T <sub>smin</sub> to T <sub>smax</sub> )	60-120 seconds
Ramp-up Rate (t <sub>L</sub> to t <sub>P</sub> )	3°C/second max.
Liquidous Temperature (T <sub>L</sub> )	217°C
Time (t <sub>L</sub> ) Maintained Above (T <sub>L</sub> )	60 – 150 seconds
Peak Body Package Temperature	260°C +0°C / -5°C
Time (t <sub>P</sub> ) within 5°C of 260°C	30 seconds
Ramp-down Rate (T <sub>P</sub> to T <sub>L</sub> )	6°C/second max
Time 25°C to Peak Temperature	8 minutes max.



CT1010-W, CT1011-W, CT1012-W, CT1013-W, CT1014-W  
CT1015-W, CT1016-W, CT1017-W, CT1018-W, CT1019-W  
**DC Input 4-Pin Long Mini-Flat Phototransistor Optocoupler**

---

## **DISCLAIMER**

CT MICRO RESERVES THE RIGHT TO MAKE CHANGES WITHOUT FURTHER NOTICE TO ANY PRODUCTS HEREIN TO IMPROVE RELIABILITY, FUNCTION OR DESIGN. CT MICRO DOES NOT ASSUME ANY LIABILITY ARISING OUT OF THE APPLICATION OR USE OF ANY PRODUCT OR CIRCUIT DESCRIBED HEREIN; NEITHER DOES IT CONVEY ANY LICENSE UNDER ITS PATENT RIGHTS, NOR THE RIGHTS OF OTHERS.

---

CT MICRO ARE NOT AUTHORIZED FOR USE AS CRITICAL COMPONENTS IN LIFE SUPPORT DEVICES OR SYSTEMS WITHOUT EXPRESS WRITTEN APPROVAL OF CT MICRO INTERNATIONAL CORPORATION.

- 1. Life support devices or systems are devices or systems which, (a) are intended for surgical implant into the body, or (b) support or sustain life, or (c) whose failure to perform when properly used in accordance with instruction for use provided in the labelling, can be reasonably expected to result in significant injury to the user.*
- 2. A critical component is any component of a life support device or system whose failure to perform can be reasonably expected to cause the failure of the life support device or system, or to affect its safety or effectiveness.*