

2J7402B

2.4 GHz ISM Screw Mount

Key Features

2.4 GHz ISM

- 2410-2490 MHz

Screw Mount

Ground Plane Dependent

Customizable Cable and Connector

Dimensions $\varnothing 60 \times 15.3$ mm

Certificates: IP67



1. Antenna and electrical specifications

Parameters	2.4 GHz ISM Antenna
Standards	WiFi, BT, ZigBee, ISM
Band (MHz)	2.4 GHz
Frequency (MHz)	2410-2490
Return Loss (dB)	~-15.5
VSWR	~1.4:1
Efficiency (%)	~56.5
Peak Gain (dBi)	~3.8
Average Gain (dB)	~-2.5
Impedance (Ohm)	50
Polarisation	Linear
Radiation Pattern	Omni-Directional
Max. Input Power (W)	25
Connector Type	SMA-Male Standard (Other Connectors Available)
Cable Length	300 cm Standard (Any Cable Length Available)
Cable Type	LMR100 Standard (Other Cables Available)

Antenna Measurement Conditions:

Mounted on 30 x 30 cm Metal Plate

100 cm of LMR100 Cable

Measured in Certified CTIA 3D Anechoic Chamber

2. Mechanical and environmental specifications

Specifications	2J7402B
Mounting Type	Screw Mount
Dimensions (mm)	Ø 60 × 15.3
Radome Type	ABS
Radome color	Black
Antenna Base	Zamak
Operating Temperature (C)	-40 to +85
Storage Temperature (C)	-40 to +85
Substance Compliance	RoHS
Certificates	IP67

3. Antenna parameters

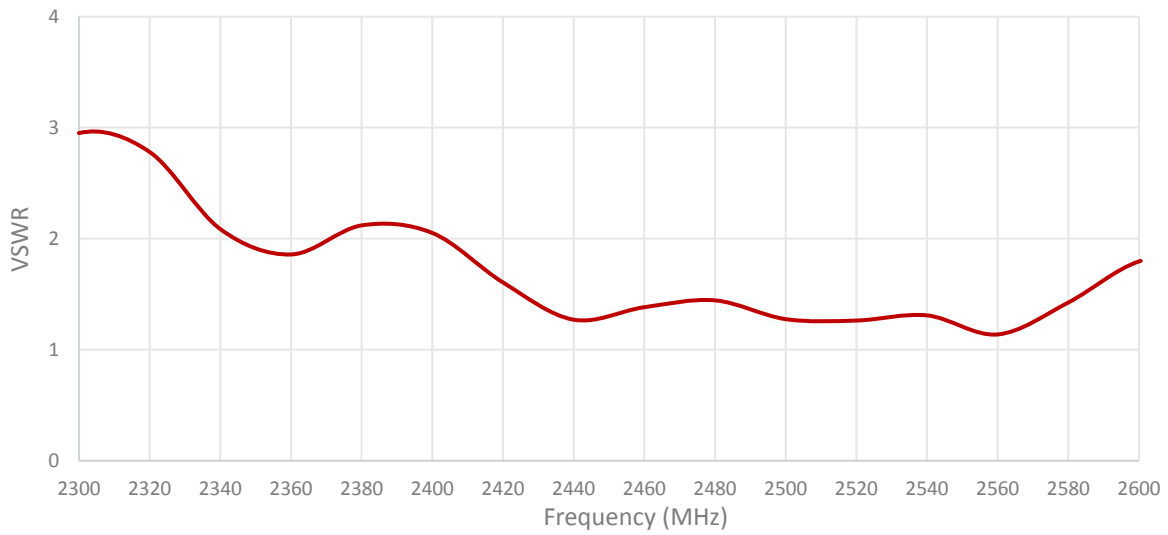
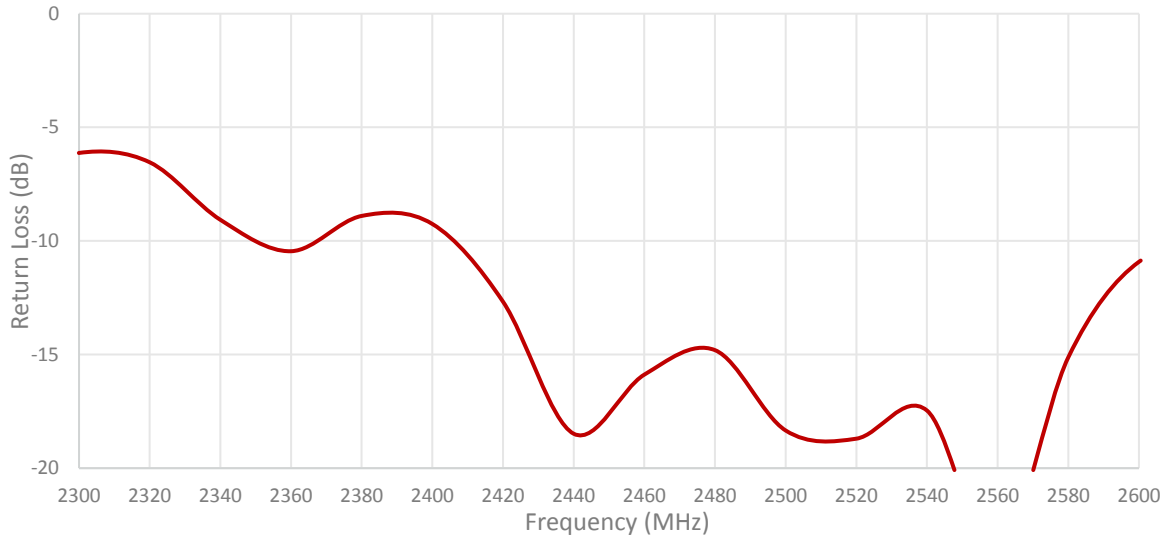

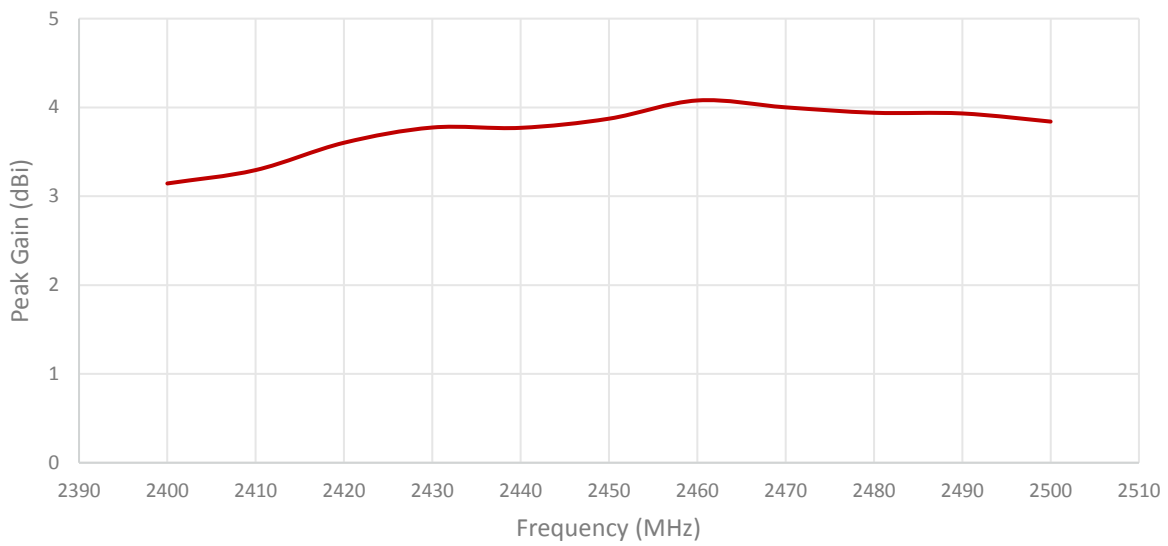
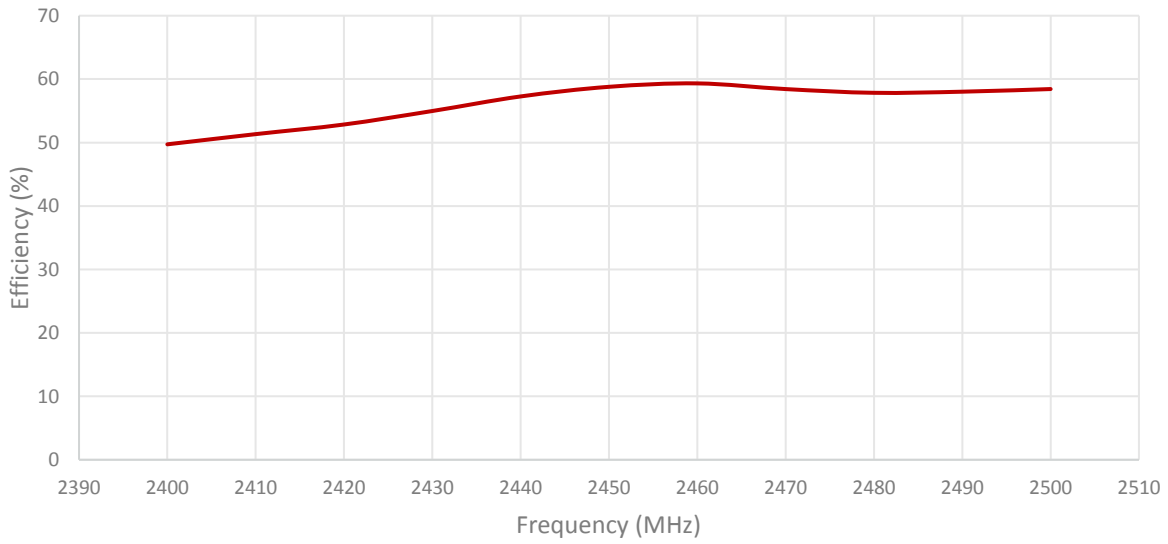

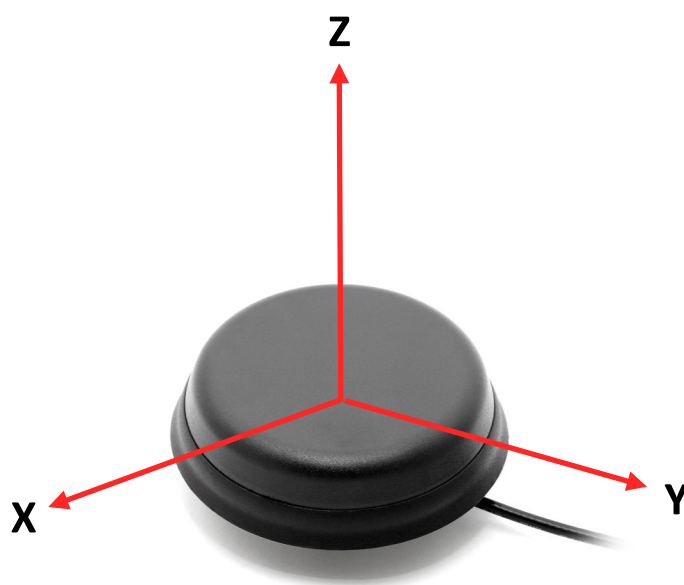
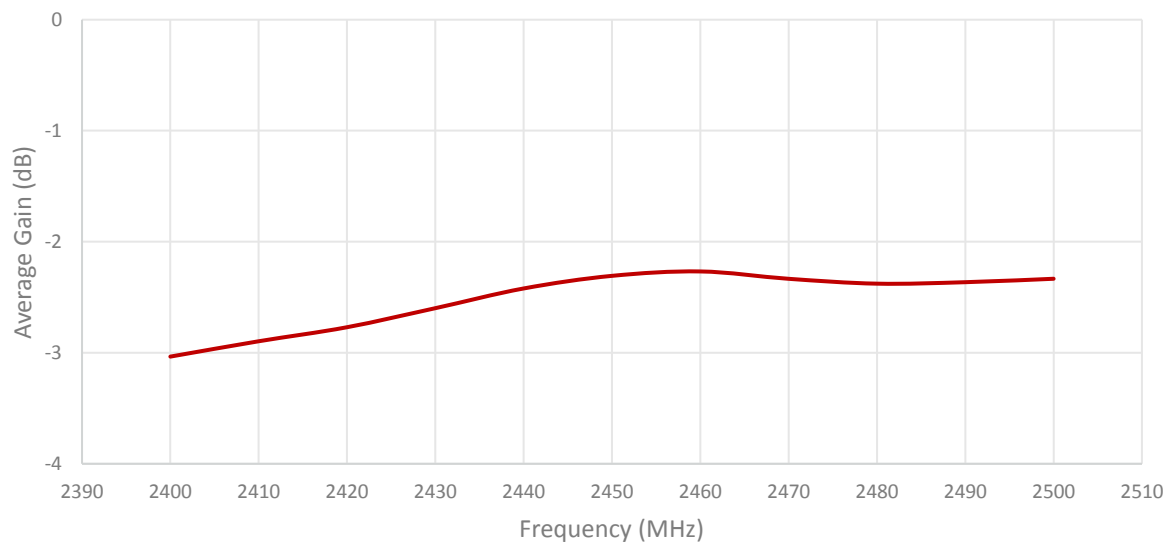

Radiation pattern reference

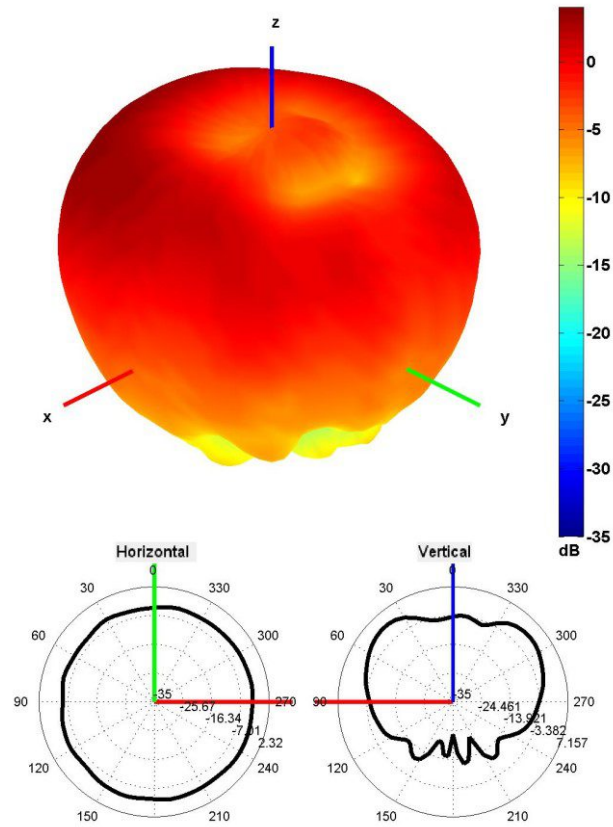

2450 MHz Radiation pattern

4. Antenna drawings

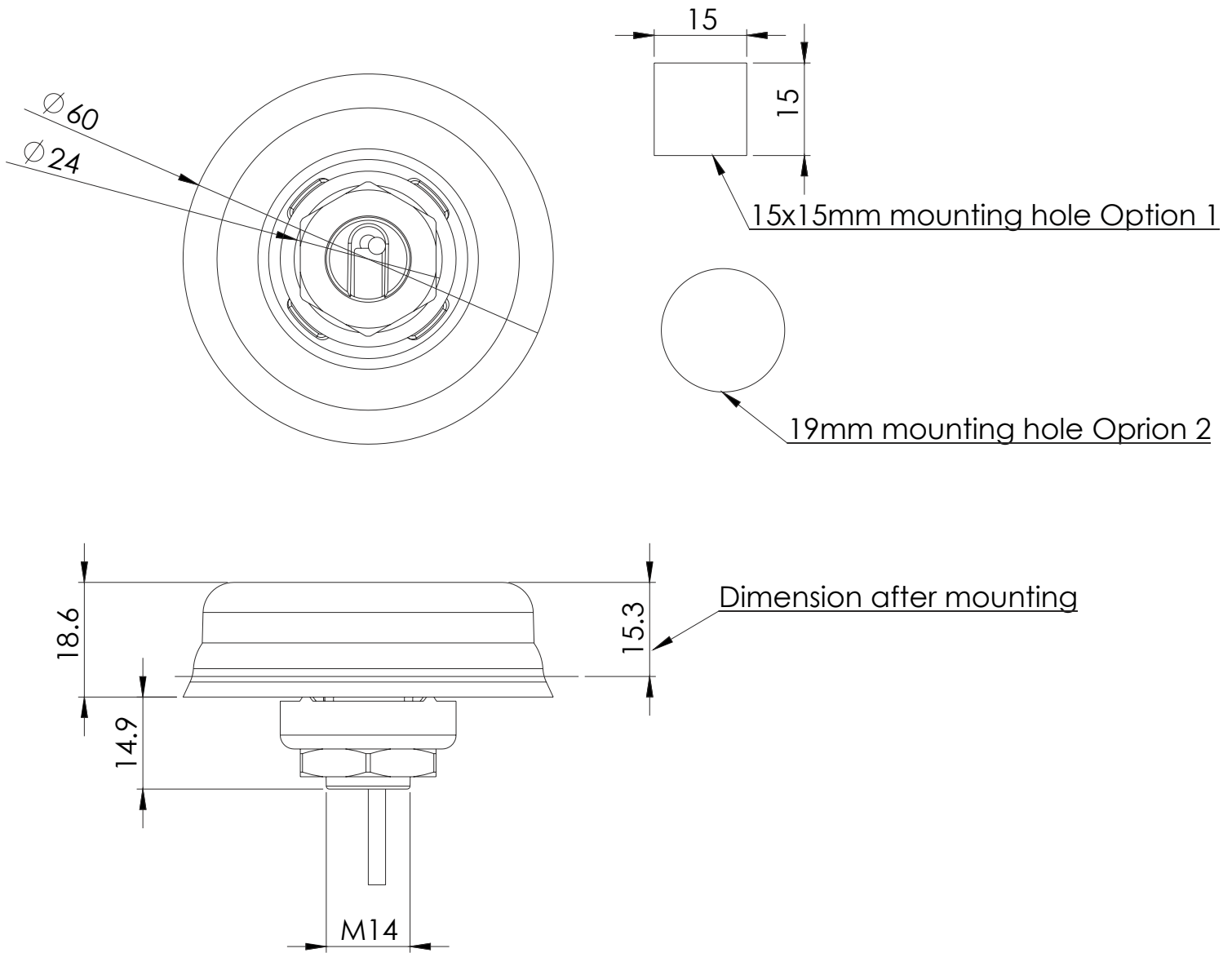

5. Antenna Images

